

Summer 8-12-2014

Cost and Probability Biases in Social Phobia: Evaluating Their Relation to Attention Bias and Treatment Outcome

Martha Calamaras
Georgia State University

Follow this and additional works at: https://scholarworks.gsu.edu/psych_diss

Recommended Citation

Calamaras, Martha, "Cost and Probability Biases in Social Phobia: Evaluating Their Relation to Attention Bias and Treatment Outcome." Dissertation, Georgia State University, 2014.
https://scholarworks.gsu.edu/psych_diss/128

This Dissertation is brought to you for free and open access by the Department of Psychology at ScholarWorks @ Georgia State University. It has been accepted for inclusion in Psychology Dissertations by an authorized administrator of ScholarWorks @ Georgia State University. For more information, please contact scholarworks@gsu.edu.

COST AND PROBABILITY BIASES IN SOCIAL PHOBIA: EVALUATING THEIR RELATION TO ATTENTION BIAS
AND TREATMENT OUTCOME

by

MARTHA R. CALAMARAS

Under the Direction of Page L. Anderson

ABSTRACT

Social phobia is maintained in part by judgmental biases concerning the probability and cost of negative social events. One hypothesized mechanism of action of cognitive behavioral therapy (CBT) for anxiety disorders is its reduction in the exaggerated probabilities and costs associated with feared outcomes, termed the “cognitive mediation hypothesis” (Foa & Kozak, 1986). A number of studies have examined the cognitive mediation hypothesis; some investigations find cost bias to be more important to treatment outcome, whereas others find probability bias to be more important. However, methodological limitations of several of these studies leave open the possibility that changes in judgmental biases are simply correlates or consequences of social anxiety reduction. Attentional processes, which mark the first discrimination of incoming information, may serve as precursors to cognitive processes like probability and cost estimates. Though intuitively linked, whether social phobics’ pattern of attending to ex-

ternal threat cues is correlated with their appraisals of the cost and probability of negative events has yet to be examined empirically. The current project examines cost and probability biases and their relation to attention bias and treatment outcome in a randomized controlled trial of CBT for social phobia. It was found that, contrary to hypotheses, greater attentional bias for threat in either direction (vigilance or avoidance) did not predict higher cost and probability estimates. However, a significant relation was observed between attentional vigilance and outcome probability estimates, such that greater vigilance for threat predicted greater estimates of the likelihood that negative social events will occur. As hypothesized, early changes in cost and probability biases predicted later changes in social anxiety symptoms (and not *vice versa*). Changes in probability estimates were a stronger predictor of treatment outcome than changes in cost estimates. Broadly, findings provide support for the cognitive mediation hypothesis of social phobia and point to both outcome cost and outcome probability as potential treatment mechanisms. Findings are discussed in the context of extant theories of social phobia, and directions for future research are proposed.

INDEX WORDS: Cost bias, Probability bias, Attention bias, Social phobia

COST AND PROBABILITY BIASES IN SOCIAL PHOBIA: EVALUATING THEIR RELATION TO ATTENTION BIAS
AND TREATMENT OUTCOME

by

MARTHA R. CALAMARAS

A Dissertation Submitted in Partial Fulfillment of the Requirements for the Degree of

Doctor of Philosophy

in the College of Arts and Sciences

Georgia State University

2014

Copyright by
Martha Rose Calamaras
2014

COST AND PROBABILITY BIASES IN SOCIAL PHOBIA: EVALUATING THEIR RELATION TO ATTENTION BIAS
AND TREATMENT OUTCOME

by

MARTHA R. CALAMARAS

Committee Chair: Page L. Anderson

Committee: Erin Tully

Erin B. Tone

Dominic Parrott

Electronic Version Approved:

Office of Graduate Studies

College of Arts and Sciences

Georgia State University

August 2014

ACKNOWLEDGEMENTS

I would like to take thank Drs. Page Anderson, Erin Tone, Erin Tully, and Dominic Parrot for their invaluable guidance and support throughout the writing of this dissertation and throughout my academic career.

TABLE OF CONTENTS

ACKNOWLEDGEMENTS	iv
LIST OF TABLES	vii
LIST OF FIGURES	viii
1 INTRODUCTION	1
1.1 Theoretical Models of Social Phobia	1
1.2 Empirical Literature on Probability Bias	8
1.3 Empirical Literature on Cost Bias.....	9
1.4 The Treatment of Social Phobia	11
1.5 Probability and Cost Biases and the Treatment of Social Phobia	13
1.6 Purpose of the Study	18
1.7 Expected Results.....	18
1.7.1 Hypothesis 1	18
1.7.2 Hypothesis 2	19
2 EXPERIMENT	19
2.1 Participants	19
2.2 Measures.....	20
2.3 Procedure	24
2.4 Treatment	26
2.5 Data Preparation	30
2.6 Preliminary Analyses	32

3	RESULTS	33
3.1	Hypothesis 1	33
3.2	Hypothesis 2	37
4	CONCLUSIONS	49
	APPENDICES	77
	Appendix A	77
	Appendix B	78
	Appendix C	79
	Appendix D	80

LIST OF TABLES

Table 2.1 Frequency of Comorbidity in the Sample.....	21
Table 2.2 Correlation Matrix of All Study Variables	31
Table 3.1 Curvilinear Regression Analysis for Threat Bias Predicting Outcome Probability.....	34
Table 3.2 Curvilinear Regression Analysis for Threat Bias Predicting Outcome Cost Estimates Curvilinear Regression Analysis for Threat Bias Predicting Outcome Cost Estimates	36
Table 3.3 2 x 2 (Time x Group) ANOVAs Comparing the Outcome and Predictor Variables at Pretreatment and Posttreatment (Step 1).....	38
Table 3.4 Descriptive Statistics for the Outcome and Predictor Variables at Pretreatment and Posttreatment for Treated and Not Treated Participants (Step 1).....	39
Table 3.5 Descriptive Statistics for the Outcome and Predictor Variables at Pretreatment, Midtreatment, and Posttreatment (Step 2).....	39
Table 3.6 Correlation Matrix of All Hypothesis 2 Study Variables at Each Time Point.....	42
Table 3.7 Chi-Square Difference Test Results and Comparative Fit Indices for Parsimonious OPQ Model	46
Table 3.8 Chi-Square Difference Test Results and Comparative Fit Indices for the Parsimonious OCQ Model.....	48

LIST OF FIGURES

Figure 2.1 CONSORT participant flow chart for Study 1	25
Figure 2.2 TREND participant flow chart for Study 2	26
Figure 3.1 Scatterplot of outcome probability estimates and threat bias scores at pretreatment	34
Figure 3.2 Scatterplot of outcome probability estimates and vigilance for threat scores at pretreatment	35
Figure 3.3 Scatterplot of outcome cost estimates and threat bias scores at pretreatment	36
Figure 3.4 Hypothesized cross-lagged panel design path model.....	41
Figure 3.5 Cross-lagged panel design path diagram with the OPQ as the predictor	45
Figure 3.6 Cross-lagged panel design path diagram with the OCQ as the predictor	47

1 INTRODUCTION

Social phobia is a marked and persistent fear of exposure to unfamiliar people or possible scrutiny by others in social or performance situations. Socially phobic individuals fear being negatively evaluated and acting in a way that will be humiliating or embarrassing. Feared situations are typically avoided or else endured with intense anxiety or distress. Fear of public speaking is the most commonly reported form of social anxiety in clinical samples (Furmark, Tillfors, Stattin, Ekselius, & Fredrikson, 2000); one study found that 34% of adults in a community sample had substantial public speaking fears (Stein, Torgrud, & Walker, 2000). Other examples of feared situations include conversing with others and eating, drinking, or writing in front of other people. Individuals with social phobia, generalized subtype exhibit intense and pervasive fears across most social situations including, but not limited to, initiating or maintaining conversations, dating, speaking to authority figures, and going to parties (APA, 2000). Data from the U. S. National Comorbidity Survey Replication estimate lifetime prevalence at 12.1%, making social phobia the fourth most common psychiatric disorder after specific phobia, major depressive disorder, and alcohol abuse (Kessler et al., 2005). During any given year, social phobia is second in prevalence only to specific phobia, affecting an estimated 6.8% of the population (Kessler, Chiu, Demler, Merikangas, & Waters, 2005). Social phobia has an enormous impact on its sufferers; socially phobic individuals have fewer years of education, are less likely to be married, are of a lower socioeconomic status, and may use drugs or alcohol in an attempt to self-medicate (Schneier, Johnson, Hornig, & Liebowitz, 1992; Craske, 1999; Ruscio et al., 2008; Stein & Kean, 2000).

1.1 Theoretical Models of Social Phobia

Theoretical models of anxiety (e.g., Beck, 1976; Beck, Emery, & Greenberg, 2005) emphasize the importance of maladaptive beliefs and biased cognitive processing in the etiology and maintenance of

anxiety disorders. Specifically, anxious individuals tend to believe that negative events are extremely likely to occur (i.e., probability bias), and that if such events were to occur, the consequences would be awful or unbearable (i.e., cost bias). Foa and Kozak (1986), in their seminal work on emotional processing theory, argued that these two types of judgmental biases are involved in the maintenance of anxiety disorders and that treatment ameliorates pathological anxiety, in part, by modifying these biases. Their hypothesis that cognitive behavioral therapy for anxiety disorders exerts its effects through reduction in the exaggerated probabilities and costs associated with feared outcomes has been termed the “cognitive mediation hypothesis.” Their theory further states that though overestimates in the cost and probability of negative events are present across all anxiety disorders, they may be of differential importance within specific anxiety disorders. For example, social phobia may be more distinguished by exaggerated cost than probability because people with social phobia hold the belief that even minor social disapproval (e.g., being turned down by a prospective date) is catastrophic.

Specific models (e.g., Clark & Wells, 1995; Rapee & Heimberg, 1997) also implicate faulty threat appraisals in the maintenance of social phobia. An assumption of Clark and Wells’ (1995) model is that individuals with social phobia believe that they are in danger of behaving in an inept and unacceptable fashion and that this behavior will result in disastrous consequences. According to this model, dysfunctional beliefs and assumptions, such as 1.) the belief that other people are holding them to a high standard of performance (e.g., “I must not make a single mistake”); 2.) the belief that their social evaluation is conditional upon their performance (e.g., “If I make a mistake, others will reject me”); and 3.) unconditional negative beliefs about themselves (e.g., “I am inadequate”) give rise to negative cognitions about the likelihood of social failure and the consequences of such failure (e.g., catastrophic embarrassment, rejection, loss of status). According to Clark and Wells, these negative cognitions trigger a shift in attentional processes in which the person engages in detailed self-monitoring during which he or she neglects the processing of incoming external information and instead focuses on spontaneous, recurrent, and

excessively negative self-images which he or she believes to be accurate. Because feared consequences are believed to be both probable and costly, physiological arousal (e.g., sweating, trembling, shortness of breath) is likely, and these interoceptive cues thus become the focus of the person's attention. This focused attention, in turn, makes physiological signs and symptoms of anxiety seem prominent and easily discernible; indeed, socially anxious people may mistakenly assume that the audience sees what he or she is feeling. In other words, they believe that their own internal impression of themselves as extremely anxious is what the audience perceives as well. Thus, self-focused attention exacerbates the experience of social anxiety.

The belief that one is being perceived in a negative way often leads the socially anxious individual to engage in compensatory strategies known as safety behaviors. These behaviors are intended to reduce the likelihood of negative evaluation, and they often involve efforts to hide physiological signals of anxiety (e.g., tightly gripping the podium or lectern to hide that one's hands are shaking). The unintended consequence of safety behaviors is that they may actually draw *more* attention to one's anxiety. Another unintended and unfortunate consequence of safety behaviors is that they serve to maintain social anxiety because, when disastrous consequences do not occur (as catastrophes typically do not), the non-catastrophic outcome is attributed to the safety behavior, rather than to the person's own abilities or the lack of danger. Thus, safety behaviors prevent disconfirmation of negative cognitions while reinforcing the maladaptive behavior.

Cognitive processing of the self and one's performance does not end with the conclusion of the social encounter, according to Clark and Wells (1995). It continues after the encounter and up until the next one in the form of post-event processing. Post-event processing is a review (or *post mortem*) of the negative elements of a social situation in which inadequacies, mistakes, imperfections, and negative perceptions of the situation are exaggerated. According to Clark and Wells, the socially phobic individual repeatedly considers and reconstructs his or her performance in a ruminative manner. Their reconstruc-

tion, however, is distorted by the biased nature of attentional and cognitive focus and is colored by impressions and images of oneself performing poorly with exaggerated anxiety, thereby strengthening social anxiety-relevant schema and contributing to the maintenance of the disorder.

Like Clark and Wells' (1995) model, Rapee and Heimberg's (1997) cognitive-behavioral model of social phobia emphasizes the importance of judgmental biases and biased attention. They suggest that persons with social phobia experience fear in social situations because they assume that others are critical and that negative evaluation is probable. Therefore, when in the presence of any person or group of people, socially anxious individuals become vigilant for any information that might signal the realization of their feared outcome (i.e., negative evaluation). To accomplish this, a person with social phobia first forms a mental representation of him- or herself. This mental representation is an image of how the person believes *others* see his or her behavior and appearance. It is usually a composite of his or her general appearance, past negative experiences that are consistent with core beliefs and negative self-schemas, internal cues (e.g., proprioceptive information like sweating, blushing), and external cues (e.g., feedback from the audience like yawning, frowning). Attentional resources are then deployed to these internal mental representations of the self as well as to any perceived threat in the social environment. (Note that this means that in the presence of social-evaluative threat, the socially anxious person's attention is divided among the mental representation of the self, threat cues in the environment, and the task at hand.) Socially anxious individuals will commonly detect negative environmental cues and discount any indicators of social success that may help disconfirm their pervasive negative beliefs (e.g., zeroing in on the one audience member who is frowning and failing to notice the three audience members who are smiling) because they are looking to find information consistent with their self-appraisal.

Concurrent with the allocation of attentional resources to potential threat, the socially anxious individual develops a prediction about the audience's standard for his or her performance. It is the discrepancy between this expected standard and the mental representation of the self that is used to eval-

uate the likelihood of negative evaluation and consider the cost of the evaluation. If the individual believes that he or she is unlikely to meet the expectations of the audience, he or she will be more likely to experience anxiety and fear negative evaluation. Thus, according to the model, anxiety will be experienced to the extent that negative evaluation is seen as likely and costly. However, recent research (e.g., Fergus et al., 2009; Weeks, Heimberg, Rodebaugh, & Norton, 2008) has highlighted the role of social scrutiny in general, including that which may result in positive evaluation from others. Accordingly, a recently updated and extended cognitive-behavioral model of social phobia (Heimberg, Brozovich, & Rapee, 2010) has highlighted fear of positive evaluation as an additional cognitive component of social phobia. Fear of positive evaluation pertains to the sense of dread associated with being evaluated favorably and publicly, which leads to direct social comparison of the self to others and therefore causes a person to feel conspicuous and in the spotlight (see Heimberg et al., 2010 for a more detailed overview).

It should be noted that these processes do not operate in isolation; rather they interact in the form of a positive feedback loop. Biased detection of audience behaviors indicative of social scrutiny would likely result in greater focus on the internal representation of the self, as the representation is based not on how one actually views oneself, but how the individual believes the audience views him or her at any given moment. Also, socially anxious individuals overestimate the extent to which their somatic symptoms of anxiety (e.g., blushing, sweating, stammering) are visible by others, which also affects the mental representation of the self as seen by the audience. In summary, according to the Rapee and Heimberg (1997) model of social phobia, vigilance for internal and external threat cues augments the socially anxious person's evaluation of the probability of his or her feared outcome, exacerbates state anxiety in the short-term, and maintains social phobia in the long-term.

Rapee and Heimberg's (1997) cognitive-behavioral model of social phobia is similar to Clark and Wells' (1995) cognitive model in its emphasis on the individual's focus on him- or herself (referred to as self-focused attention by Clark and Wells and mental representations of the self as seen by the audience

by Rapee and Heimberg). Attention to threatening stimuli is also a key feature of both models of social anxiety. Vigilance for threat cues in the environment, according to Rapee and Heimberg, is similar in function to the vigilant internal focus described by Clark and Wells in that in each case, the socially anxious individual scans for information regarding the likelihood of negative outcomes. However, the models diverge on the phenomenon of vigilance for threat in the external environment. Clark and Wells assert that socially anxious persons attend almost exclusively to internal cues and that internal self-focus is most important to the experience of anxiety and the poorer performance of socially anxious individuals. In contrast, Rapee and Heimberg contend that, in addition to internal cues, socially anxious persons are vigilant to threat cues in the external environment. Indeed, a recent meta-analysis of the literature on attention and anxiety found that anxious individuals, including those with social phobia, do exhibit reliable and robust vigilance for threat when data are aggregated across studies (Bar-Haim, Lamy, Pergamin, Bakermans-Kranenburg, & van Ijzendoorn, 2007). However, individual empirical studies of socially anxious samples suggest that threat vigilance is not uniformly evident (for a review, see Bögels & Mansell, 2004). Although most studies find that, on average, individuals with social phobia or symptoms show a tendency to attend toward threat cues; (i.e., a vigilant bias; e.g., Mogg & Bradley, 2002;), other studies show a tendency to attend away from threat cues (i.e., an avoidant bias; e.g., Mansell, Clark, Ehlers, & Chen, 1999) or a tendency to initially attend to threat cues and later avoid; (i.e., a vigilant-avoidant pattern of attention; e.g., Garner, Mogg, & Bradley, 2006) or no bias at all (e.g., Bradley et al., 1997). Methodological differences across studies, including variations in task type (e.g., Stroop versus dot probe), stimulus type (e.g., faces, words, household objects), and stimulus presentation duration offer one potential explanation for these mixed findings (Schultz & Heimberg, 2008). Another explanation is that there are different types of attentional bias among socially anxious adults, with some individuals showing vigilance toward and others showing avoidance of socially threatening stimuli. Indeed, Calamaras, Tone, and Anderson (2012) argued that social phobics may comprise two subgroups on the basis of the

direction their attention bias (avoidant, vigilant) and that these subgroups change in different ways following treatment. Price, Tone, and Anderson (2011) found that an avoidant bias at pretreatment was associated with reduced treatment response to CBT for social phobia; Waters, Mogg, and Bradley (2012) recently replicated this finding in a sample of children with a primary diagnosis of generalized anxiety disorder or social phobia, providing further evidence for the utility of attention bias subtypes.

Theoretically, biased attention allocation may be linked to biased cognitive processing among individuals with social phobia. Clark and Wells (1995) argue that excessive attention directed toward the self may prevent individuals with social phobia from processing social cues and receiving accurate information regarding social situations. Indeed, recent studies have found that probability and cost biases partially mediated the relation between mindfulness (which is negatively related to self-focused attention) and social phobia symptoms using cross sectional (Schmertz, Masuda, & Anderson, 2012) and longitudinal (Morgan et al., 2013) designs. Similar to Clark and Wells' assumption that individuals with social phobia believe that they are in danger of behaving in an inept and unacceptable fashion and that this behavior will result in disastrous consequences, Rapee and Heimberg (1997) state that people with social phobia have a response bias, or a consistent and natural characteristic tendency, to overestimate the likelihood and consequences of negative evaluation. However, they also state that cost and probability estimates are "based on preceding stages of the model" (p. 749), one of which is the preferential allocation of attentional resources to internal and external indicators of negative evaluation. Heinrichs and Hofmann (2001) also posit that biased attentional allocation is the pathway by which individuals with social phobia inaccurately interpret social threat. The authors argue that because attention marks the first discrimination of incoming information, attentional processes serve as precursors to cognitive (interpretive and judgmental) processes, such as cost and probability biases, in social phobia. Intuitively, one could see hypervigilance for threat leading directly to increased probability estimates (because one is seeing any and all possible indicators of threat to the exclusion of neutral or positive stimuli). Alterna-

tively, individuals with high probability bias may be more attentionally avoidant so as to protect themselves from attending to social cues that they view as having a high probability of being negative. Perhaps, since attention bias is hypothesized to play an important role in the etiology and maintenance of social anxiety, there is a dose-response relationship between attentional bias and social anxiety symptoms and cognitions, such that greater attentional bias leads to more biased cognitions which, in turn, lead to increased symptoms. This hypothesis is somewhat supported by the findings of a study by Pishyar, Harris, and Menzies (2007), in which positive correlations were found between reductions in attentional vigilance and reductions in self-report measures of social anxiety.

Though attentional biases have been found to occur extremely rapidly (e.g., 17 ms; Mogg & Bradley, 2002), it is also true that the meaning assigned to a social situation influences attentional processes. For example, Mathews & Mackintosh (1998) suggested that a situation must first be interpreted as a social threat before attentional processes can be dispatched accordingly. Accordingly, one could see high cost estimates as leading to increased attentional avoidance as an effort to circumvent or prevent the catastrophic cognitions that could be prompted by social threat cues. Thus attentional and judgmental processes may occur in an interrelated, rather than linear sequence.

In spite of the strong theoretical and intuitive rationale, an as yet unasked question is whether social phobics' pattern of attending to external threat cues is related to their appraisals of the cost and probability of negative events. The following sections first review the empirical literature on probability and cost biases before turning to how the present study addresses this question.

1.2 Empirical Literature on Probability Bias

There is substantial empirical support for the presence of a bias regarding the probability of social events in individuals with social phobia. In a nonclinical sample of undergraduate students, Smári, Bjarnadottir, and Bragadottir (1998) found a significant positive correlation between social anxiety symptoms and probability overestimates of severely negative social outcomes (e.g., "You will make a

fool of yourself.”). Foa and colleagues (1996), comparing 15 individuals diagnosed with social phobia to 15 nonanxious controls, found that social phobics overestimated the probability of mild negative social events (e.g., “Someone you know won’t say hello to you”) relative to nonanxious controls. McManus, Clark, and Hackmann (2000) extended these findings by including an additional control group: participants meeting criteria for another DSM-IV anxiety disorder (e.g., obsessive compulsive disorder). The authors found that participants with social phobia had significantly higher estimates of the probability of both mildly and severely negative social events than did the nonanxious and non-socially anxious control groups. The one study that has examined probability of positive social events (Lucock & Salkovskis, 1998) found that, in addition to rating negative outcomes as more likely to occur than controls did, they also rated *positive* social outcomes as *less* likely to occur. These three studies suggest that social phobia is associated with biased probability estimates; however, they are limited by their reliance on self-report measures and hypothetical situations. Only one study (Andrews, Freed, & Teesson, 1994) used a behavioral assessment. In this study, participants diagnosed with social phobia were required to either speak or eat in front of strangers and asked to rate the probability that they would feel “silly and embarrassed and be noticed to be so by other people” at three time points: prior to entering the situation, while in the situation, and after leaving the situation. Compared to nonanxious controls, individuals with social phobia rated the likelihood of embarrassment significantly higher, and ratings made in anticipation were consistently higher than ratings made either in the situation or after leaving it. In conclusion, research has documented the presence of a pervasive bias regarding the probability of mildly negative, severely negative, and positive social events in clinical and nonclinical socially anxious samples, using both self-report and behavioral methods.

1.3 Empirical Literature on Cost Bias

Theorists have argued that inflated probability estimates of the likelihood of negative social events are unlikely to cause anxiety unless the negative social event is considered aversive or to have a

negative consequence. That is, if an event is perceived as likely but not harmful, it will not be appraised as threatening or anxiety provoking. Therefore, inflated cost estimates for negative social events have been hypothesized to be the driving force behind social phobia fears (Foa & Kozak, 1986).

Smári et al. (1998) asked nonclinical participants to rate the severity of five negative social events and found that cost estimates were significantly correlated with social anxiety symptoms. Uren, Szabó, and Lovibond (2004) replicated these findings in a clinical sample and found that, compared to nonanxious controls, the clinically socially anxious rated the negative social outcomes as more distressing, which the authors interpret as evidence of overestimates in the appraisal of the cost of the outcomes. Two other studies found evidence of cost bias in clinical participants when compared to nonanxious controls. One found overestimates in the cost of mildly negative social events (Foa et al, 1996), and another found overestimates in both mildly and profoundly negative social events (McManus et al., 2000). One limitation of these studies, however, is that they relied heavily on self-report Likert/Likert-type measures.

Three studies (Stopa & Clark; 2000; Gilboa-Schechtman, Franklin, & Foa, 2000; Wilson & Rapee, 2005) have used open-ended assessments in an effort to clarify why individuals with social phobia perceive negative social events as more costly. Stopa and Clark (2000) asked individuals with social phobia and nonanxious controls to interpret ambiguous (e.g., an audience member leaving in the middle of a speech) and mildly negative social events. The authors found that individuals with social phobia were more likely to generate negative and catastrophic explanations for events than controls. Gilboa-Schechtman, Franklin, and Foa (2000) had participants rate several dimensions of both positive and negative social events and found that individuals with social phobia reported more physically and emotionally intense reactions, changes in self-esteem, and longer reactions (i.e., 48 hours versus 2 hours) than nonanxious controls. Similar results were found for positive events, which is consistent with the notion that positive events can also be interpreted as threatening by people with social phobia because they

increase standards for future performances (Wallace & Alden, 1995; Heimberg et al., 2010). Lastly, Wilson and Rapee (2005) asked people diagnosed with social phobia and non-socially anxious controls to imagine themselves in a negative social situation (e.g., “You go to a party, and spend a lot of time standing on your own”) and indicate their degree of belief in four interpretations of the situation. Results showed that social anxiety was associated with the tendency to believe that negative social events would result in negative evaluation by other people, indicate negative personal characteristics, and yield adverse consequences in the long-term future. In sum, structured and unstructured assessments have been used to demonstrate that socially anxious individuals view both positive and negative social events as more catastrophic than do nonanxious controls, providing reliable evidence for the presence of inflated cost estimates in social phobia.

To review, the current research literature suggests that social phobia is associated with pervasive biases concerning the probability and cost of social events. Evidence of attentional vigilance for external cues indicative of social threat cues also has been demonstrated within socially phobic samples. Extant models of social phobia provide a strong theoretical link between attentional and judgmental biases; however these relations have yet to be examined empirically. The following sections provide an overview of treatment interventions for social phobia, a review of the scientific literature examining cost and probability biases in the context of treatment for social phobia, and culminate in the rationale for the present proposal.

1.4 The Treatment of Social Phobia

The treatment of choice for social phobia is cognitive behavioral therapy (CBT), which incorporates various treatment components including exposure-based strategies, cognitive restructuring, anxiety management training, and social skills training (Barlow et al, 2003; Rodebaugh et al, 2004).

Exposure refers to the repeated and systematic confrontation of feared stimuli and is considered “an essential ingredient underlying efficacious psychological treatment for anxiety disorders”

(Moscovitch, Antony, & Swinson, 2009, p. 461). Exposure therapy involves repeated confrontation of a feared stimulus in the absence of a feared outcome, resulting in decrements in fear. Research on the mechanisms of exposure therapy draws from the principles of operant and classical conditioning and learning theory. More recently, the term *extinction* has been favored to refer to the decrease in responding that occurs when the link between a feared stimulus (e.g., public speaking) and the fear response (e.g., anxiety regarding the likelihood of negative evaluation) is weakened. It is this uncoupling of the feared stimulus and fear response that leads to extinction. Current theory suggests not that the fear is completely eliminated, but rather that a new, more adaptive response (e.g., behavioral approach rather than avoidance or the thought that public speaking is unlikely to lead to catastrophic outcomes) is learned that comes to co-exist in competition with the original fear. This process is known as safety learning.

Exposure therapy may be done in a natural setting (*in vivo*), by imagination (*in vitro*), or through the use of virtual technologies (*in virtuo*). Regardless of the route of administration, effective exposure therapy must be repeated, prolonged, and controlled (Foa & Kozak, 1986). According to Foa and Kozak, in order for fear reduction to occur: 1.) the fear memory must be activated (as measured by subjective and physiological fear responses to the feared stimuli), and 2.) the encoding of new information incompatible with the fear network must occur. The fear network typically includes overestimated probabilities about the likelihood that confronting feared stimuli will produce harmful consequences, as well as catastrophic beliefs about how harmful those consequences will be. Anxious individuals also tend to believe that their anxiety response will persist indefinitely, spiral out of control, and/or cause psychological or physical harm. Experiencing information incompatible with feared beliefs should therefore promote learning that the actual probability of feared consequences occurring is much lower than originally believed and that the consequences are not as aversive as expected. Therefore, effective exposure in-

volves learning that “the feared situation constitutes no real danger from without, as well as information that anxiety reactions are of finite intensity and duration” (Foa & Kozak, p. 28).

Other components of CBT for social phobia typically include identification of safety behaviors and their adverse effects, attention retraining (e.g., shifting focus of attention to the external social situation to reduce problematic self-monitoring and obtain more accurate information about people’s response; Wells, White, & Carter, 1997), video feedback to modify distorted self-imagery, behavioral experiments in which patients specify their feared outcomes for various social situations and test whether they occur during planned exposure, and identification and modification of problematic anticipatory and post-event processing (Stangier, Heidenreich, Peitz, Lauterbach, & Clark, 2003).

CBT has been found to be superior to other psychotherapeutic approaches in the percentages of people improving, degree of improvement, as well as long-term effects in follow-up studies (Fava et al., 2001). Comparison of pharmacological treatment with CBT reveals that both are effective in reducing social phobia symptoms. Though pharmacological treatment works faster, relapse rates are greater than for CBT (Sadock & Sadock, 2007). Of cognitive behavioral interventions for social phobia, cognitive behavioral group therapy (CBGT) has received the most empirical support and is the “gold standard” for treatment of social phobia (Rodebaugh et al., 2004; Heimberg, 2002). CBGT consists of cognitive restructuring, self-guided *in vivo* exposure with other group members, and cognitive restructuring homework (Heimberg, Dodge, Hope, & Kennedy, 1990). Positive follow-up findings for CBGT in the treatment of social phobia have been reported at six months and up to five years after the end of treatment (Heimberg, et al., 1990; Heimberg, Salzman, Holt, & Blendell, 1993). Despite the demonstrated efficacy of CBT, knowledge regarding the underlying variables that lead to treatment change is limited (Hofmann, 2000).

1.5 Probability and Cost Biases and the Treatment of Social Phobia

Recall that Foa and Kozak (1986) proposed that one mechanism of action in CBT is its reduction in the exaggerated probabilities and costs associated with feared outcomes. They further proposed that

the absence of negative consequences would alter the exaggerated probability estimates and that habituation (extinction) of anxiety during exposure to feared situations would reduce inflated cost estimates through a process of emotional reasoning: "If I am not anxious, the situation cannot be so bad." For example, if during a role-play, mild criticism ceases to evoke physiological arousal, then being criticized is no longer perceived as disastrous. These biases have also been challenged through the use of social mishap exercises, in which patients evaluate their beliefs about social threats and costs by intentionally engaging in flawed social behaviors in a real world setting, and through guided discussions in which the patient is asked, (e.g., "What would be the worst outcome of this situation?" "Why is this situation such a catastrophic event?" "How will your life change as a result of this event?"; Hofmann & Scepkowski, 2006).

Numerous empirical studies have hypothesized that CBT exerts its effect by modifying judgmental biases and, indeed, studies have consistently shown that successful treatment of social anxiety is associated with significant changes in probability and cost biases. Several studies have simply assessed whether these biases change following treatment. Results of four studies (Franklin, Huppert, Langner, Leiberg, & Foa, 2005; Luckock & Salkovskis, 1988; Poulton & Andrews, 1996; Voncken & Bogels, 2006) have demonstrated that CBT is associated with significant reductions in cost and probability biases. These studies did not examine whether changes in these biases actually predict or mediate treatment outcome.

A number of recent studies have examined the cognitive mediation hypothesis (e.g., Foa et al., 1996; Hofmann, 2004; McManus et al., 2000). Although these studies have varied with respect to design, measures, and analytic strategies, they converge with respect to some basic methodological features. Specifically, all have included measures of the proposed mediators (judgmental biases) and clinical status (i.e., social anxiety) before and after treatment (i.e., pretreatment, posttreatment, and follow-up assessment). Furthermore, all have assessed judgmental biases using self-report measures that ask

respondents to indicate the perceived probability and cost associated with hypothetical negative social scenarios (e.g., “during a job interview, you will freeze,” “someone you know will not say hello to you”). Foa and colleagues (1996) examined the role of cost and probability biases in treatment for social phobia and found that, after controlling for pretreatment symptom severity, depression, and changes in probability estimates, changes in cost estimates were strongly correlated with posttreatment anxiety. However, after controlling for initial anxiety, depression, and cost estimates, changes in probability bias were only moderately correlated with treatment outcome. The authors interpret their findings as evidence that cost estimates—but not probability estimates—“mediate” treatment outcome, and as consistent with the notion asserted by Foa and Kozak that cost is a more influential/driving/underlying force in social phobia.

Employing a similar statistical design (i.e., examining changes in cost and probability as predictors of posttreatment anxiety), McManus et al. (2000) found apparently contradictory results. After controlling for initial symptom severity and change in cost bias, probability remained a significant predictor of posttreatment symptoms; however, change in cost bias was no longer a significant predictor after controlling for change in probability and pretreatment severity.

Though the above studies are informative, true tests of whether a variable is treatment mechanism require demonstration that changes in the predictor precede changes in the dependent variable (Kramer, Wilson, Fairburn, & Agras, 2002). Four investigations have conducted formal mediational analyses in the context of CBT for social phobia. Two of these investigations (Hofmann, 2004; Wilson & Rapee, 2005) examined cost but not probability bias. Two others (Smits, Rosenfield, McDonald, & Telch, 2006; Nelson, Deacon, Lickel, & Sy, 2010) examined both types of judgmental biases.

In a randomized controlled trial comparing CBT and exposure therapy without explicit cognitive interventions, Hofmann (2004) assessed social anxiety symptoms and cost estimates at three time points (pretreatment, posttreatment, and six-month follow-up) and found that change in cost estimates

was a significant mediator of change in both the CBT and exposure therapy conditions, an intriguing finding given that the exposure-alone treatment did not target cognitions. Only the CBT group, however, showed continued improvement from the posttreatment to six-month follow-up period, which led the author to conclude that cognitive interventions lead to better *maintenance* of treatment gains, and that these gains were mediated through changes in estimated social cost. The author notes that multiple assessments of the proposed mediator during the course of treatment (versus in the follow-up period) would have provided data for “a finer analysis of the temporal relationship between these variables” (p. 397).

Wilson and Rapee (2005) also examined cost bias as a mediator of treatment outcome in a randomized trial investigating the effect of adding bibliotherapy to cognitive behavioral group treatment for social phobia. Cost bias was defined as the extent to which negative social events: 1.) were suggestive of negative personal characteristics; 2.) carried long-term consequences; and 3.) would result in negative evaluation. Ratings were collected at three time points: pretreatment, posttreatment, and three-month follow-up. A series of hierarchical multiple regression analyses revealed that the three cost estimates significantly predicted posttreatment symptoms; however, only the belief that negative social events were indicative of negative personal characteristics remained a significant predictor of symptoms at follow-up. The authors conclude that this pattern of findings suggests that the degree to which negative social events are viewed as indicative of unfavorable self-characteristics may be more important than costs related to consequences in interpersonal relationships/interactions.

The conclusion that reduction of cost bias is more important than reduction of probability bias has been challenged. Smits, Rosenfield, McDonald, and Telch (2006), in a randomized trial investigating the efficacy of videotape feedback procedures, examined both cost and probability biases as mediators of fear reductions within session. Participants meeting criteria for social phobia were assigned to one of four treatment conditions (exposure + video feedback of performance; exposure + video feedback of

audience reactions; exposure without video feedback; or credible placebo), and SUDS ratings were collected at five within-session time points across three 75-minute sessions within a one week period. To test their hypothesis, a three-step analytic approach was used : 1.) piecewise growth model to assess change as a function of time; 2.) an individual growth modeling approach termed *lower level mediation* (Kenny, Korchmaros, & Bolger, 2003) to assess whether reductions in judgmental bias accounted for reductions in fear; and 3.) a cross-lagged panel design to assess the direction of the relations between cost and probability biases and fear. Results indicated that 1.) reductions in judgmental biases occurred both within and between sessions; 2.) change in probability bias accounted for a greater proportion of variance in fear reduction than change in cost bias; and 3.) reduction of probability bias resulted in fear reduction, whereas reduction in cost bias was a *consequence* of fear reduction. That is, only reductions in probability estimates truly mediated treatment outcome. This finding is inconsistent with the assertion that reductions in cost are a stronger factor than reductions in cost for fear reduction. A limitation of this study is that the number of treatment sessions ($n = 3$) was too few to conduct an analysis of between-session change; thus the authors' finding of mediation is limited to within-session processes. The authors propose as a direction for future research applying their analytic strategy to a longer treatment protocol to provide valuable information about change between treatment sessions.

Although studies have consistently shown that successful treatment of social anxiety is associated with significant changes in judgmental biases, the relative importance of changing probability versus cost bias for achieving social anxiety reduction has not been examined using an experimental design until recently. Nelson, Deacon, Lickel, and Sy (2010) assigned 37 undergraduates scoring high in public speaking fear to a single-session intervention condition designed to reduce either the perceived probability or perceived cost of negative outcomes associated with public speaking. The authors found that participants in the cost condition demonstrated significantly greater improvement on measures of pub-

lic speaking anxiety and that this improvement was mediated by greater changes in cost estimates.

However this study used a nonclinical sample and a single-session intervention.

In sum, probability and cost biases are influential in the treatment of social phobia. Research has shown that changes in these biases correlate with, predict, and mediate change. However, this literature is limited on several fronts. First, some investigations find cost to be more important, whereas others find probability to be more important. Second, probability bias has yet to be examined as a true mediator in a typical (i.e., 8 weekly sessions in a clinical sample) treatment outcome study. Third, several studies of treatment mechanisms measured the relevant variables only before and after treatment and therefore failed to establish that changes in judgmental biases temporally preceded changes in outcome. To ascertain whether changes in probability and cost biases precede changes in social anxiety (or *vice versa*) requires that the variables of interest be assessed repeatedly during the course of treatment (Kraemer et al., 2002; Kazdin & Nock, 2003; Smits, Powers, Cho, & Telch, 2004).

1.6 Purpose of the Study

The primary goals of the current research project were to examine cost and probability biases and their relation to attention bias and treatment outcome in a randomized controlled trial of CBT for adults diagnosed with social phobia. The aims of the present investigation were: 1.) to examine the relation between judgmental biases and attention bias in a clinical sample at pretreatment; and 2.) to examine whether changes in judgmental biases predict treatment outcome.

1.7 Expected Results

1.7.1 Hypothesis 1

Given the lack of previous empirical literature examining the possible relation between judgmental biases and attention bias, Hypothesis 1 was exploratory in nature. Specifically, it was hypothesized that attention bias (both vigilance for and avoidance of threat) will predict cost and probability bi-

ases at pretreatment, such that greater bias in either direction (vigilant or avoidant) will predict higher cost and probability estimates (i.e., a dose-response relationship).

1.7.2 Hypothesis 2

Changes in cost and probability estimates will predict reductions in social anxiety symptoms, but change in cost will be a stronger predictor of treatment outcome than change in probability.

2 EXPERIMENT

The present study was part of two larger treatment studies. The first study was funded by the National Institutes of Mental Health (NIMH) and compared Exposure Group Therapy (EGT) and Virtual Reality Exposure Therapy (VRE) for Social Phobia to wait-list controls (WL) using a randomized, controlled design. The attention bias task was added to this study toward the end of participant recruitment. The second study was funded by the Anxiety Disorders Association of America (ADAA) and examined amygdala activity as a predictor of treatment response to VRE using functional magnetic resonance imaging (fMRI), in an uncontrolled trial with a small sample. The attention bias task was included in this study from its inception. For the purposes of this study, the procedures are the same, with the exception that participants in the fMRI study were not randomly assigned to treatment; they all received VRE.

2.1 Participants

Participants were 100 individuals who met DSM-IV (APA, 2000) criteria for a primary diagnosis of generalized ($n = 49$) or non-generalized social phobia ($n = 51$), identified public speaking as their most feared social situation, and who either: a) completed treatment; or b) were eligible for treatment and completed the dot probe task. Eligible participants on psychoactive medication were required to be stabilized on their current medication(s) and dosage(s) for at least 3 months and to remain on the stabilized

regimen throughout the course of the study. Exclusion criteria included (a) history of mania, schizophrenia, or other psychoses; (b) recent prominent suicidal ideation; (c) current alcohol or drug abuse or dependence; (d) inability to wear the virtual reality helmet; (e) history of seizures; and (f) inability to undergo an fMRI (e.g., claustrophobia, metallic implants; Study 2 only). Additionally, participants were required to be literate in English.

Most participants ($n = 78$; 78%) received a diagnosis of Social Phobia alone. The most common secondary diagnoses were Specific Phobia ($n = 7$), Panic Disorder without Agoraphobia ($n = 3$), Generalized Anxiety Disorder, ($n = 3$), Obsessive Compulsive Disorder ($n = 3$), and Major Depression ($n = 3$). More detailed comorbidity information can be found in Table 2.1. The sample consisted of 61% females ($n = 61$) and 39% males ($n = 39$). Participants' ages range from 19 to 69 with a mean age of 39.17 ($SD = 11.3$). The ethnic distribution of the sample was representative of the setting in which recruitment took place (urban Atlanta). Most participants self-identified as "Caucasian" ($n = 47$; 47%) or "African American" ($n = 34$; 34%). Four participants (4%) self-identified as "Hispanic," 3 (3%), as "Asian American," and 10 (10%) as "Other" ("African American/Indian/Caucasian" = 1; "Chinese" = 1; "African" = 1; "Biracial" = 1; "Eritrean American" = 1; "Arabic" = 1; "African American/Caucasian" = 1; Declined to Answer = 3). Sixty-two percent reported that they had completed college, 49% were married or living with someone as though married, and 44% had an annual income of \$50,000 or greater.

2.2 Measures

The following measures were used to assess demographics, diagnostic status, social anxiety, judgmental biases, and attention bias.

Demographic Questionnaire (Appendix A). A series of questions were developed to assess demographic information.

Table 2.1 Frequency of Comorbidity in the Sample

Diagnosis	Primary Diagnosis	Secondary Diagnosis	Third Diagnosis	Fourth Diagnosis	Fifth Diagnosis
Social Phobia: Generalized	49				
Social Phobia: Public Speaking	51				
Specific Phobia		7	3	1	0
Major Depression		3	1	0	0
Generalized Anxiety		3	3	0	1
Dysthymia		2	0	0	0
Panic D/O w/o Agoraphobia		3	0	0	0
Obsessive Compulsive D/O		3	0	0	0
PTSD		0	0	1	0
Hypomania		0	0	1	0
Alcohol Abuse		1	0	0	0

Structured Clinical Interview for the DSM-IV (SCID; First, Gibbon, Spitzer, & Williams, 2002).

The SCID is a structured diagnostic clinical interview used to assess psychological disorders based upon the criteria of the DSM-IV. The instrument is designed to be administered by a trained mental health professional. Several studies (Basco et al., 2000, Fennig, Craig, Lavelle, Kovaszny, & Bromet, 1994; Kranzler, Kadden, Babor, & Tennen, 1996) have demonstrated superior diagnostic validity of the SCID over standard clinical interviews at intake. The administration time of the SCID can range from about 15 minutes for a subject with virtually no psychopathology or psychiatric history to up to several hours for a subject with extensive psychiatric comorbidity. The administration time of the full SCID for a psychiatric patient averages around 90 minutes. For the current project, the SCID was used to determine eligibility

status and the diagnostic status of a variety of Axis I conditions falling within the mood, alcohol/substance use, and anxiety disorders modules.

Brief Fear of Negative Evaluation (BFNE; Watson & Friend, 1969; Appendix B). The BFNE is a 12-item self-report questionnaire that assesses cognitions about negative evaluation for a variety of situations. Responses are measured on a 5-point Likert scale (1 = not at all, 5 = extremely) with overall scores ranging from 5 to 60. The BFNE has demonstrated excellent internal consistency (Cronbach's $\alpha = .94 - .98$) and 1 month test-retest reliability ($r = .78 - .94$). Work with a normative sample of individuals diagnosed with social phobia ($n = 165$) has reported a mean of 46.91 ($SD = 9.27$) (Weeks, et al., 2005). The internal consistencies for the current study were as follows: good for pretreatment ($\alpha = 0.88$), excellent for midtreatment ($\alpha = 0.90$), and good for posttreatment ($\alpha = 0.89$).

Outcome Probability Questionnaire (OPQ; Uren et al., 2004; Appendix C). The OPQ is a 12-item self-report questionnaire that assesses an individual's estimate of the probability that negative socially threatening events will occur. Items are scored on a 9-point Likert scale (0 = not at all, 8 = extremely) with summary scores ranging from 0 to 96. Internal consistency for the measure has been found to range from good to excellent (Cronbach's $\alpha = .89 - .90$; Uren et al., 2004). The internal consistencies for the current study were as follows: good for pretreatment ($\alpha = 0.86$), excellent for midtreatment ($\alpha = 0.91$), and excellent for posttreatment ($\alpha = 0.91$).

Outcome Cost Questionnaire (OCQ; Uren, et al., 2004; Appendix D). The OCQ is a 12-item self-report questionnaire that assesses an individual's estimate of the cost of negative social events. Items are scored on a 9-point Likert scale (0 = not at all, 8 = extremely) with summary scores ranging from 0 to 96. Internal consistency for the measure has been found to be consistently in the excellent range (Cronbach's $\alpha = .92 - .94$; Uren et al., 2004). The internal consistencies for the current study were as follows: good for pretreatment ($\alpha = 0.85$), excellent for midtreatment ($\alpha = 0.90$), and excellent for posttreatment ($\alpha = 0.91$).

Dot Probe Task. A modified version of the dot probe task was used to assess attentional bias toward threatening faces relative to neutral and positive faces. The stimuli and task were the same as those used by Mogg and Bradley (1999) and consisted of 128 stimulus faces from 64 different models, each posing two facial expressions: one neutral and the other either threatening or happy. Thus, there were 32 threatening faces and 32 happy faces, each matched with a neutral face of the same person. There were 128 critical trials in which each of the 64 face pairs was presented twice, once with the emotional face on the left, and once on the right. Thus, there were 64 threat-neutral face pairs and 64 happy-neutral pairs. In addition to the 128 critical trials, there were 32 filler trials of neutral-neutral face pairs. In total, the dot probe task comprised 160 experimental trials presented in a new random order to each participant. A brief practice trial of five face pairs preceded the task.

Participants were seated approximately 120 cm in front of a computer screen and instructed to “hover” the first two fingers of their dominant hand over the “1” and “2” buttons of the keyboard. Participants were then informed they would see faces presented on the screen in pairs, one on the left side of the screen and one on the right side of the screen. They were advised that when the faces disappeared, a small dot would appear in the spatial location of one of the faces, and that when this occurred, they were to press the “1” or “2” button on the keyboard to identify the location of the dot (left or right) as quickly as possible. On each trial a focus stimulus (a “+”) appeared in the center of the screen for 500 ms followed by a face pair for 500 ms. The probe was presented immediately after the offset of the face pair and remained on the screen for 1100 ms. It appeared on the left and right sides of the screen an equal number of times. The inter-trial interval varied randomly between 500 and 1250 ms. The images were digitally sized to approximately 45 x 70 mm.

Emotion bias scores are calculated by subtracting response time to emotion-incongruent stimuli (probes that replace neutral pictures) from response time to emotion-congruent stimuli (probes that replace happy or threatening pictures). These bias scores can be further decomposed into threat and

happy bias scores. For threat bias, a positive value indicates a shift of attention toward the threatening face relative to the neutral face (vigilance), and a negative value indicates a shift away from the threatening face toward the neutral face (avoidance). Previous research conducted with this task suggests that it validly discriminates between adults diagnosed with Social Phobia and normal controls (Mogg, Philippot, & Bradley, 2004), as well as between controls and adults diagnosed with GAD (Bradley, Mogg, White, Groom, & de Bono, 1999).

2.3 Procedure

This study was approved by the Georgia State University Institutional Review Board, and written informed consent for study procedures was obtained. Participants were self-referred or recruited through area professionals, newspaper advertising, posted flyers, and publicity efforts. Eligibility for the study was determined through a two-part process consisting of a brief telephone screening and a subsequent in-person, pretreatment assessment. After expressing interest and consenting to complete a telephone screening, study candidates completed a short phone interview to determine if they met obvious exclusion criteria (e.g., current substance abuse, metallic implants in Study 2 only). Initial telephone screenings were conducted by doctoral students in the clinical psychology program at GSU and consisted of a series of questions related to mood, anxiety, and substance use. Those who were not excluded during the telephone screening were given the opportunity to participate in an in-person, pretreatment assessment at Georgia State University. Consent was obtained prior to the in-person pretreatment assessment as well.

Figures 2.1 and 2.2 were prepared in accordance with guidelines outlined in the CONSORT (Consolidated Standards of Reporting Trials; Altman, et al., 2001) and TREND (Transparent Reporting of Evaluations with Nonrandomized Designs; Des Jarlais, Lyles, & Crepaz, 2004) statements. The figures show the flow of participants through the two treatment studies. In Study 1, the pretreatment assessment included a structured diagnostic clinical interview (SCID) administered by a doctoral student, a battery of

self-report measures, and the dot probe task. Eligible participants were then randomly assigned to VRE, EGT, or WL (See Figure 2.1). In Study 2, the pretreatment assessment was identical to that of Study 1 except it included an additional “mock” fMRI to ensure participants could tolerate an actual fMRI. Following the pretreatment assessment, eligible participants then underwent an fMRI at a nearby hospital. These participants were not randomly assigned to treatment groups, and all received VRE Therapy (See Figure 2.2).

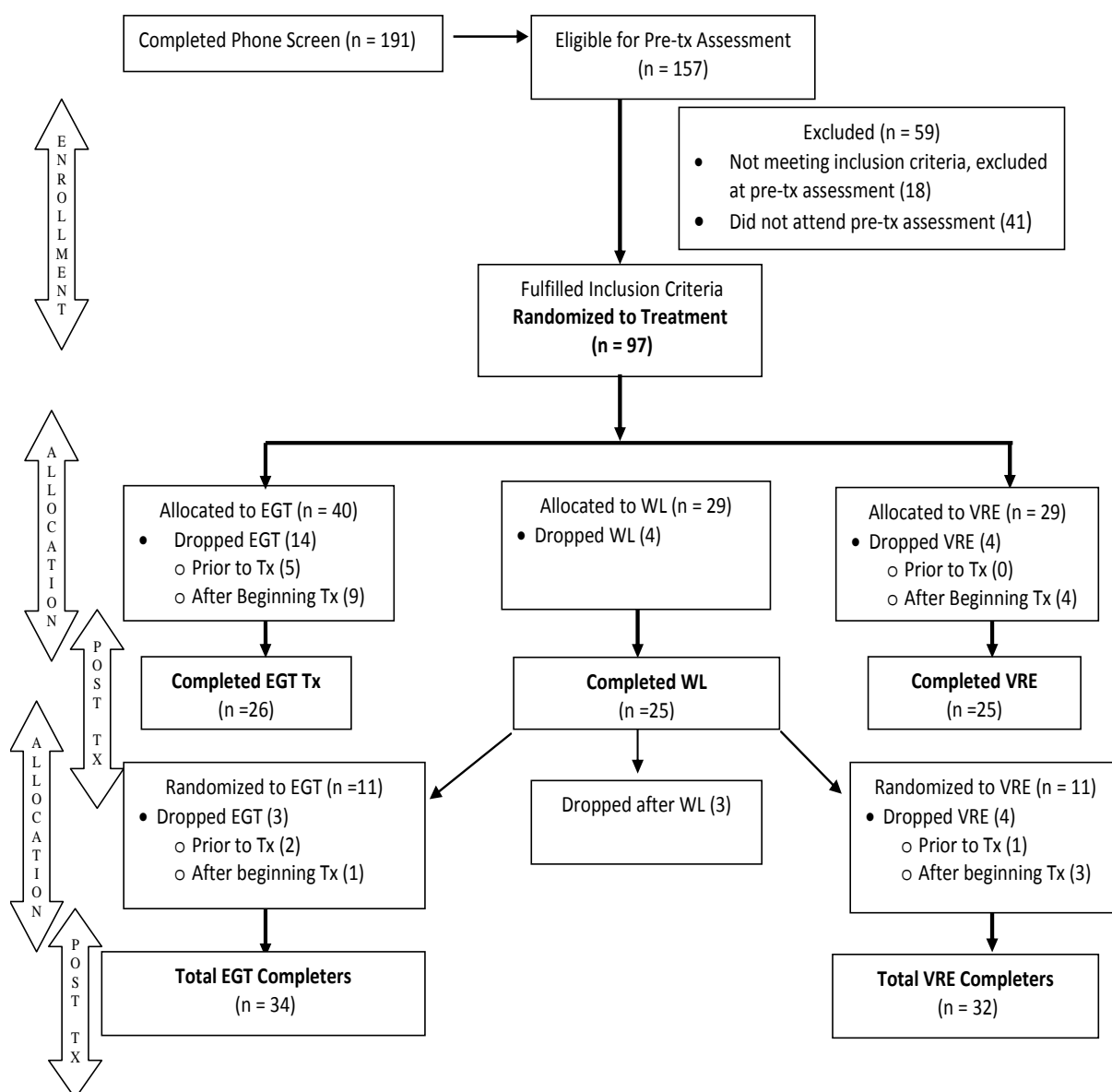

Figure 2.1 CONSORT participant flow chart for Study 1

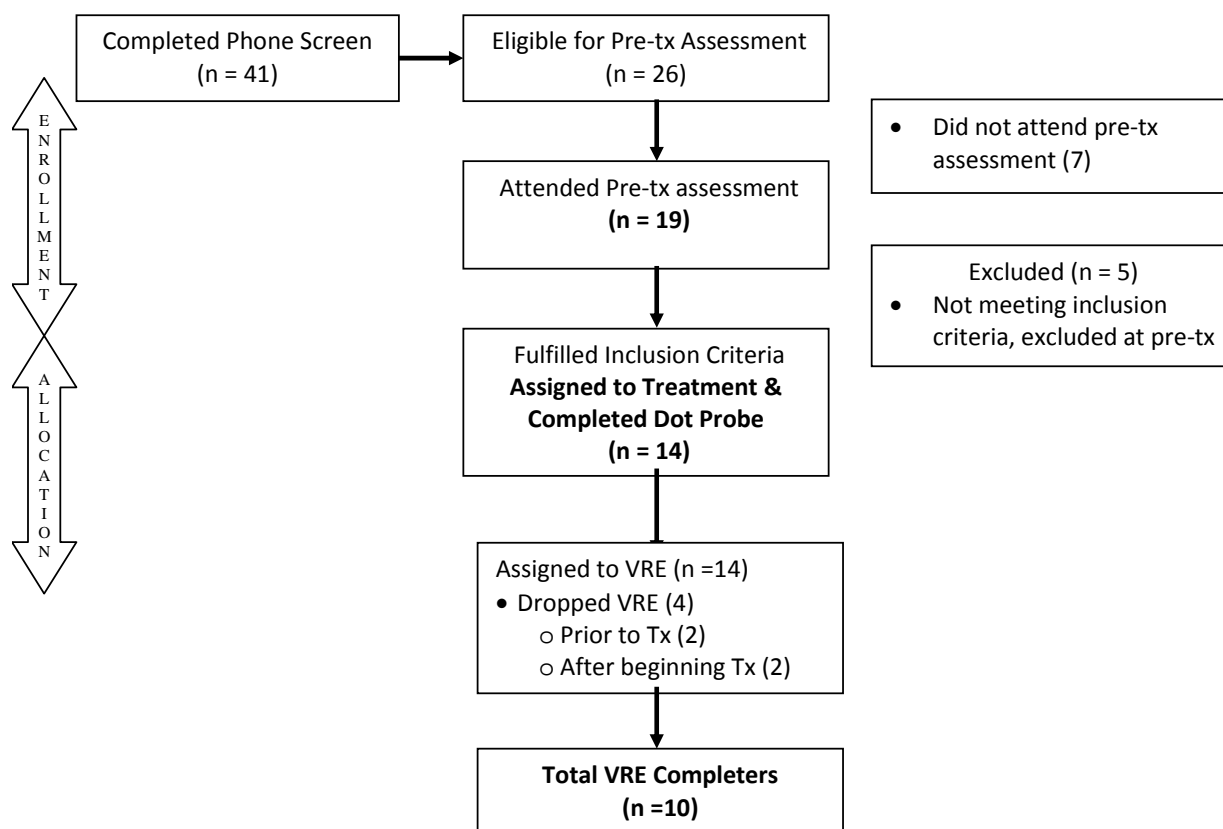

Figure 2.2 TREND participant flow chart for Study 2

All pretreatment diagnostic assessments were videotaped, and a randomly selected subset was reviewed by a licensed psychologist to calculate the inter-rater reliability of pretreatment assessments (100% agreement for primary diagnosis).

2.4 Treatment

Prior to administering therapy, study therapists attended a two-day training workshop led by the developers of the respective treatments. Each of the study therapists also received weekly supervision by the primary investigator of the study. In Study 1, ratings of treatment integrity and competence were completed by the developers of the respective treatments for a randomly selected subset of the sessions (14%). Compliance was quite good for each treatment, with 92% and 93% of the essential ele-

ments of the protocol being completed for VRE and EGT, respectively, and one infraction for each treatment arm across all sessions reviewed. Competence in delivering each element was also rated for these sessions, using a 7-point scale (1- very poor to 7-excellent). The competence ratings also were quite good, with a mean quality rating of 6.1 for VRE and 5.4 for EGT. The same therapists were used in Study 1 and Study 2.

The VRE and EGT treatment groups were designed to be as similar as possible, with the exception of the modality for the delivery of exposure. Both treatments specifically targeted public speaking fears via exposure therapy. Furthermore, both treatments sought to address specific aspects of Social Phobia identified in psychopathology literature, including self-focused attention, perceptions of self and others, perceptions of emotional control, rumination, and realistic goal setting for social situations. The mechanism and setting through which exposure was delivered varied for each of the two treatment groups. Individual study therapists relied on the virtual environment to facilitate exposure to public speaking fears (VRE), while group therapists relied on other group members to help facilitate exposure (EGT). The majority of participants ($n = 42$) completed VRE, and the remaining ($n = 34$) completed EGT.

Virtual Reality Exposure (VRE). VRE was implemented according to a manualized treatment protocol (Anderson, Zimand, Hodges, & Rothbaum, 2005) and was administered individually by either a licensed psychologist ($N = 2$) or an advanced doctoral student in the clinical psychology program ($N = 3$). VRE treatment consisted of eight therapy sessions conducted over a period of approximately eight weeks. During session one, participants were introduced to the VRE treatment rationale, which provides psychoeducation about the nature of cost and probability biases, and taught how to identify and rate their anxiety on a subjective units of discomfort scale (SUDS). Breathing training was also introduced. Session two began with a review of the treatment rationale and then focused on teaching the concept of cognitive restructuring, including its purpose and practice. Probability and cost biases were specifical-

ly targeted and challenged via guided discussions in which evidence for and against these cognitions was evaluated. Session three focused on self-perceptions during public speaking. During this session, participants reviewed video of their pretreatment speeches and were asked to compare how anxious they looked on the video to how anxious they rated themselves while giving the speech. Session four focused on identifying the role that both safety behaviors and self-focused attention can play in the maintenance of Social Phobia. Participants were first videotaped demonstrating their most commonly used safety behaviors while giving a prepared talk. Next, participants were instructed to focus their attention on the audience and to refrain from using safety behaviors while being videotaped giving the same talk. Then, participants were able to observe the two videos to see how their performance and anxiety differed when they focused on the audience while giving their talk versus when they engaged in safety behaviors and self-focused attention while speaking. Exposure exercises were conducted during sessions five through eight using the virtual audience. During VRE exposure exercises participants were fitted with a head mounted display containing screens for each eye, stereo headphones and a head tracking device, through which they were exposed to one of three virtual environments. VR exposure environments included a virtual conference room (~5 audience members), a virtual classroom (~35 audience members), and a virtual auditorium (appearance of 100+ audience members). VRE therapists had the ability to manipulate the reactions of the audience in a number of ways including making them appear interested/bored, supportive/hostile, distracted (e.g., cell phone ringing), as well as the ability to manipulate the difficulty of questions that were posed by the audience. Virtual environments were manipulated according to the client's goals for treatment and their pre-constructed fear hierarchy. Participants were exposed to each item on their hierarchy until their reported fear was reduced by 50 percent before being exposed to their next item on the hierarchy. Treatment concluded with a review of the different anxiety management and relapse prevention strategies.

Exposure Group Therapy (EGT). EGT (Hofmann, 2002) consisted of eight group sessions of manualized treatment over a period of eight weeks which were co-led by a licensed clinical psychologist and an advanced doctoral student. Groups consisted of up to five participants. During session one, participants were introduced to the EGT treatment rationale, which also included a discussion of cost and probability biases, as well as the theoretical basis for exposure therapy. Session two began with a review of the treatment model; participants were then asked to engage in their first exposure exercise which consisted of giving a brief speech about the Social Phobia treatment models in front of the group. Furthermore, self-perceptions were addressed in session two, and video from each client's treatment model speech was used as a mechanism to help participants highlight discrepancies between how anxious they appeared on video and how anxious they rated themselves prior to viewing the video. Group members were also asked to provide each other with positive feedback when the videotaped speeches were reviewed. Sessions three through six followed a similar model to that of session two. Session seven includes real-world exposure exercises. During this session, participants exited the lab to engage in social mishap exercises on the GSU Campus. The social mishap exercise provided participants with the opportunity to evaluate their beliefs about social threats and costs by intentionally engaging in flawed social behaviors in a real world setting, while still in the presence of continued support from other group members/therapists. The final session provided participants with tools to prevent relapse and included a review of what was learned over the course of therapy.

Wait List (WL). The WL period (Study 1 only) lasted eight weeks after which participants completed a battery of post WL questionnaires similar to the battery that is administered after both the EGT and VRE treatments. Then, WL participants were randomly assigned to either VRE or EGT and received the same 8 week treatment protocol described above.

2.5 Data Preparation

Predictive Analytics SoftWare (PASW) Statistics, version 18.0 was used for data entry, storage, and analyses. Accuracy and quality of data entry were monitored through the process of double entry.

Threat bias scores. Data were inspected for errors, excessive missing cases, and outliers in accordance with the procedures used in Mogg, Bradley, and Philippot (2004). Two participants (97 and 103) were determined to have both excessive errors (14% and 8% respectively) and excessive missing cases (27% and 12% respectively) and were therefore excluded from analyses. Reaction times (RTs) less than 200 *ms* and greater than two standard deviations above the mean were defined as outliers. It was determined that one participant had an excessive number of outliers (13%); however this participant had already been excluded due to excessive errors and missing cases (participant 97). Threat bias scores were calculated by subtracting average reaction time to probes replacing threatening faces from average reaction time when probes replace neutral faces. Positive bias scores indicate faster responses to probes following threatening stimuli (vigilance), whereas negative scores indicate slower responding to probes following threatening stimuli (avoidance). This method of calculating threat bias scores produces results identical to those obtained using the difference formula described by MacLeod and Mathews (1988):

$$\text{Threat Bias Score} = 0.5 * [(TrPl - TlPl) + (TlPr - TrPr)]$$

where T = threat face, P = probe, l = left position, and r = right position.

Mean threat bias scores for each subject were computed at pretreatment by averaging bias scores from all trials.

Assumptions. Prior to conducting analyses, data were first inspected for errors, excessive missing cases, outliers, normality, and multicollinearity using the approach described in Tabachnik & Fidell (2007).

To detect outliers and assess for normal variable distributions, boxplots, Q-Q plots, and histograms with an overlaid normal curve were graphed. Outliers were defined using the criterion of greater than or equal to three standard deviations above or below the mean of the distribution. One variable (the OCQ at pretreatment) had three data points that were greater than three standard deviations below the mean; these data points were discarded. To test for normality, data were visually inspected, and their skewness and kurtosis statistics were divided by their standard errors to produce z scores. This method produced no z scores greater than 1.96; thus it was concluded that no variable's distribution was significantly nonnormal at the $\alpha = .05$ level. To assess for multicollinearity, a correlation matrix of all measures at each time point was computed (see Table 2.2). Though several correlations within a single measure at different time points were quite high (e.g., the correlation between the BFNE at pretreatment and the BFNE at midtreatment was .72), no correlations between different measures were greater than 0.7, suggesting the measures do not convey essentially the same information.

Table 2.2 Correlation Matrix of All Study Variables

	1	2	3	4	5	6	7	8	9	10
1 Pre-BFNE	1	.72**	.59**	.47**	.47**	.41**	.43**	.41**	.28**	-.04
2 Mid-BFNE		1	.63**	.39**	.54**	.46**	.28*	.53**	.37**	-.24
3 Post-BFNE			1	.39**	.63**	.70**	.23*	.46**	.53**	-.30
4 Pre-OPQ				1	.65**	.56**	.57**	.41**	.32**	.32
5 Mid-OPQ					1	.81**	.24*	.61**	.47**	.23
6 Post-OPQ						1	.29**	.60**	.65**	-.05
7 Pre-OCQ							1	.38**	.39**	.14
8 Mid-OCQ								1	.72**	.13
9 Post-OCQ									1	-.01
10 Pre-T.Bias										1

Note: BFNE = Brief Fear of Negative Evaluation; OPQ = Outcome Probability Questionnaire; OCQ = Outcome Cost Questionnaire. * = Correlation is significant at the .05 level; ** = Correlation is significant at the .01 level

2.6 Preliminary Analyses

To confirm that random group assignment produced an equal distribution of demographics and responses to the self-report measures at the pretreatment assessment across experimental groups (EGT, VRE, and WL) in Study 1, correlational analyses and a series of one-way Analyses of Variance (ANOVA) were conducted. There were no significant differences between the treatment conditions with regard to demographics or self-report measures, suggesting sufficient randomization. Thus participants in the EGT and VRE groups were combined to form a total of two experimental groups (Treated [EGT + VRE], Not Treated [WL]). Previous outcome research on Study 1 (Anderson et al., in press) has shown that, relative to WL, both EGT and VRE were associated with significant symptom improvements on all but one measure (length of speech during a behavioral avoidance task for EGT and self-reported fear of negative evaluation for VRE), and at posttreatment, there were no differences between the EGT and VRE groups on any process or outcome measure.

Independent samples t-tests and correlational analyses were then conducted to determine whether participants from the controlled trial (Study 1) and the uncontrolled trial (Study 2) were significantly different in terms of demographics and responses to the self-report measures at the pretreatment assessment. There were no significant differences between Study 1 and Study 2 on any of the metrics listed above; however, there was a significant difference between Study 1 and Study 2 with regard to threat bias scores ($t(38) = -4.676, p < .001$). Participants from Study 1 evidenced a slight avoidant bias ($m_{\text{Threat Bias}} = -3.33$), whereas participants from Study 2 evidenced a vigilant bias ($m_{\text{Threat Bias}} = 21.77$). Given that study membership at pretreatment does not directly bear on testing and interpreting the hypothesis involving attention bias, as planned, participants from Study 2 were added to the Treated group from Study 1 to increase sample size.

3 RESULTS

3.1 Hypothesis 1

Attentional biases (vigilance for and avoidance of threat) will predict cost and probability biases at pretreatment, such that greater bias in either direction (vigilant or avoidant) will predict higher cost and probability estimates.

Because this aim involved only data from pretreatment, all participants from Study 1 and Study 2 who were eligible for treatment and completed the dot probe task were included in the analyses. Two participants were excluded from analyses due to an excessive number of missed trials, errors, and/or outliers, resulting in a total sample size of $N_{Total} = 40$ ($n_{Study 1} = 25$; $n_{Study 2} = 15$). Consistent with previous investigations of attention bias in adults diagnosed with social phobia, the overall sample demonstrated a slight vigilance for threat ($M = 6.08$; $SD = 20.38$). The scores ranged from -29.07 to 55.21, with 37.5% of participants ($n = 15$) demonstrating avoidance of threat cues (defined as threat bias scores less than zero), and 62.5% of participants ($n = 25$) demonstrating vigilance for threat cues (defined as threat bias scores greater than zero). To test whether vigilance for and avoidance of threat predicted cost and probability biases, two separate curvilinear regression analyses were conducted (one with OPQ as the outcome variable, and one with OCQ as the outcome variable). Curvilinear regression analyses can be used to determine if a quadratic relationship exists between two variables. A 'quadratic' relationship refers to a non-linear relationship between X and Y . In this case, it was hypothesized that as threat bias scores approached zero or neutral, cost and probability estimates would be lower, whereas increased threat bias scores in either direction (vigilance or avoidance) would predict higher cost and probability estimates, forming a U-shaped curve. Hierarchical multiple regression analyses were used to test the hypothesis that a quadratic relationship exists between threat bias and judgmental biases. The first regression analysis regressed scores on the OPQ at pretreatment onto threat bias scores at pretreatment in Step 1, followed by the squared threat bias scores (Threat Bias²) in Step 2 of the model. Neither Step

1, ($F[1,38] = 0.948$, Mean Square = 464.34, $p = ns$) nor Step 2, ($F[1, 37] = 1.85$, Mean Square = 444.35, $p = ns$) was significant, suggesting there was neither a linear nor quadratic relationship between outcome probability estimates and threat bias (see Table 3.1).

Table 3.1 Curvilinear Regression Analysis for Threat Bias Predicting Outcome Probability

Variable	<i>B</i>	<i>SE B</i>	R^2 Change	<i>t</i>	<i>p</i>
Step 1					
Threat Bias	.165	.169	.024	.974	ns
Step 2					
Threat Bias ²	.011	.006	.067	1.646	ns

Figure 3.1 presents the scatterplot of threat bias and OPQ scores.

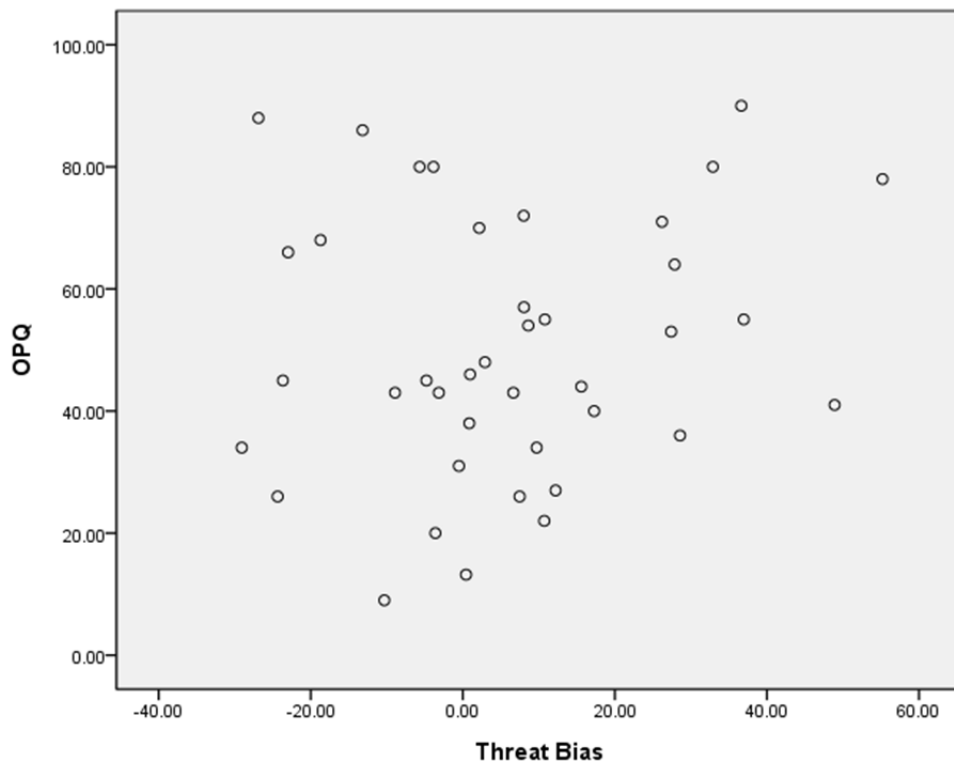

Figure 3.1 Scatterplot of outcome probability estimates and threat bias scores at pretreatment

The data are not U-shaped, confirming that greater bias in either direction (vigilant or avoidant) does not predict higher probability estimates. However, given visual inspection of the scatterplot and the paucity of literature examining the relations between attentional and judgmental biases, an additional regression analysis was conducted using the vigilance scores (i.e, all positive, untransformed threat bias scores) as the predictor variable and the OPQ as the outcome variable. It was found that degree of vigilance for threat was predictive of outcome probability estimates ($B = .581$, $SE_B = .232$, $t = 2.505$, $R = .463$, $p < .05$), such that higher vigilance scores among the individuals who had a tendency toward vigilance predicted greater OPQ scores (see Figure 3.2).

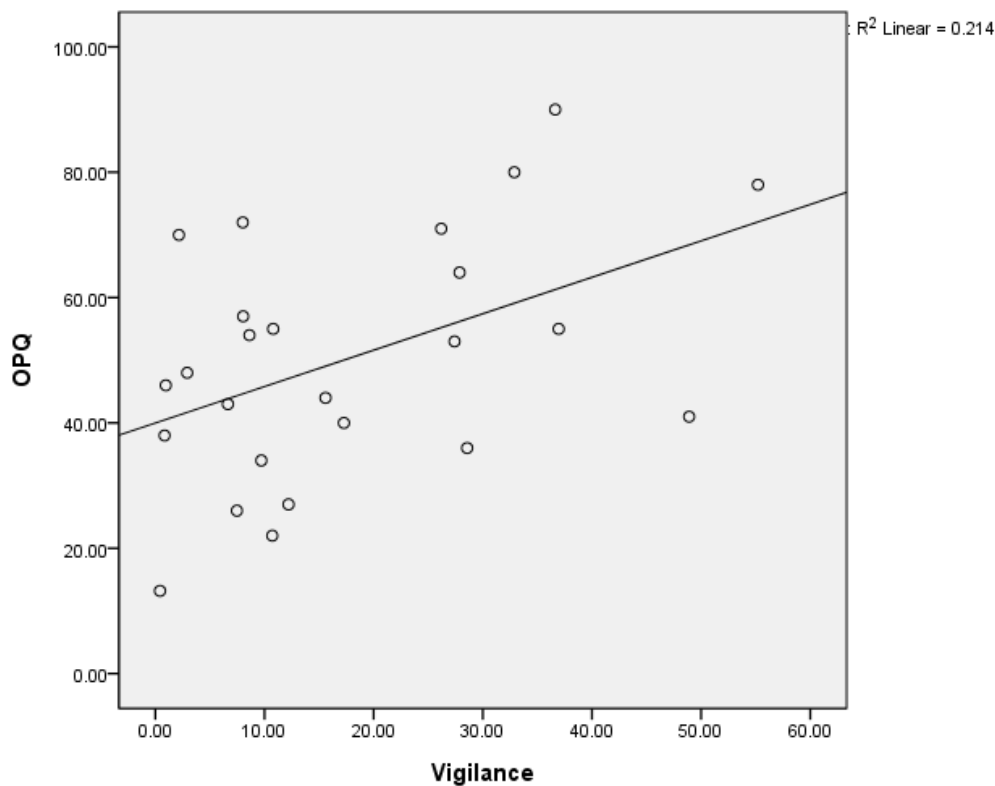

Figure 3.2 Scatterplot of outcome probability estimates and vigilance for threat scores at pre-treatment

Ancillary analyses revealed that degree of avoidance of threat was not predictive of outcome probability estimates ($B = -.346$, $SE_B = .699$, $t = .495$, $R = .136$, $p = ns$).

The curvilinear regression analyses were then repeated with the OCQ as the outcome variable. Scores on the OCQ at pretreatment were regressed onto threat bias scores at pretreatment in Step 1, followed by the squared threat bias scores (Threat Bias²) in Step 2 of the model. Results for the OCQ were similar to the results for the OPQ. Neither Step 1, ($F[1,38] = 0.321$, Mean Square = 322.05, $p = ns$) nor Step 2, ($F[1, 37] = .185$, Mean Square = 330.24, $p = ns$) was significant, suggesting there was neither a linear nor quadratic relationship between outcome cost estimates and threat bias (see Table 3.2).

Table 3.2 Curvilinear Regression Analysis for Threat Bias Predicting Outcome Cost Estimates

Variable	<i>B</i>	<i>SE B</i>	<i>R</i> ² Change	<i>t</i>	<i>p</i>
Step 1					
Threat Bias	.080	.141	.008	.567	ns
Step 2					
Threat Bias ²	.001	.006	.002	.241	ns

Figure 3.3 presents the scatterplot of threat bias and OCQ scores.

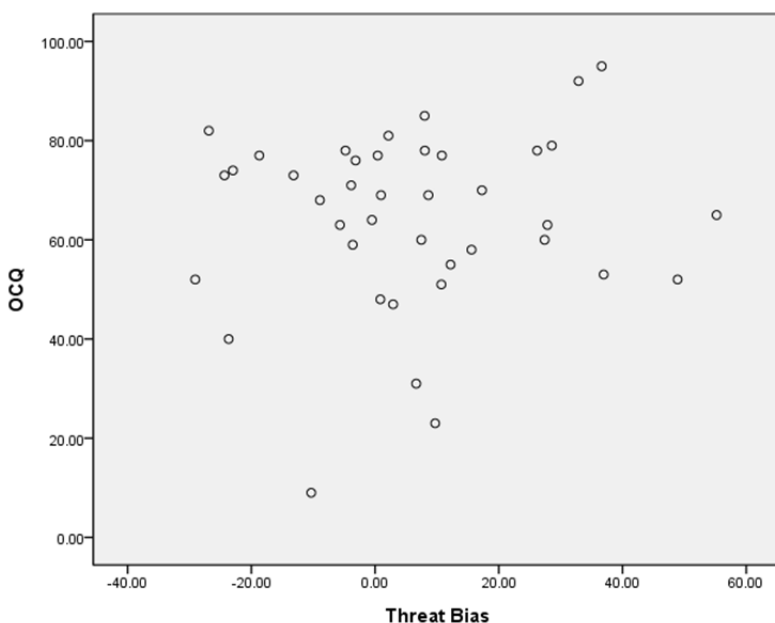

Figure 3.3 Scatterplot of outcome cost estimates and threat bias scores at pretreatment

The data are not U-shaped, confirming that greater bias in either direction (vigilant or avoidant) does not predict higher cost estimates. Ancillary analyses revealed that outcome cost estimates were not significantly predicted by either degree of vigilance for threat ($B = .184, SE_B = .234, t = .786, R = .162, p = ns$) or by degree of avoidance of threat ($B = .024, SE_B = .522, t = .045, R = .013, p = ns$).

3.2 Hypothesis 2

Changes in cost and probability estimates will account for reductions in social anxiety symptoms, but changes in cost will be a stronger predictor of treatment outcome than changes in probability.

Evaluating this hypothesis involved a series of analytical steps. First, the effect of treatment on cost and probability estimates (OPQ, OCQ) and on social anxiety symptoms (BFNE) was tested. Second, the contributions of changes in cost and probability estimates to treatment outcome were evaluated. Third, the relative influence of changes in cost versus probability estimates on social anxiety symptoms were compared to determine if one was a stronger predictor of treatment outcome.

Step 1. Did treatment have an effect on cost and probability estimates and social anxiety symptoms? To determine if treatment was associated with significant reductions in social anxiety symptoms and outcome cost and probability estimates, participants who were initially assigned to and who completed treatment in Study 1 ($n = 51$) or who completed treatment in Study 2 ($n = 10; N_{Treated} = 61$) were compared to the WL participants from Study 1 ($N_{Not Treated} = 25$) to test whether participants' scores on the OPQ, OCQ, and BFNE were significantly reduced following treatment. A series of 2 x 2 mixed design ANOVAs was conducted with Time (pretreatment, posttreatment) as the within-subjects/repeated measures variable and Group (Treated, Not Treated) as the between-subjects variable. For all variables, a main effect for Time was found, as well as a statistically significant Group x Time interaction (see Table 3.3).

Table 3.3 2 x 2 (Time x Group) ANOVAs Comparing the Outcome and Predictor Variables at Pretreatment and Posttreatment (Step 1)

	<i>df</i>	<i>F</i>	<i>p</i>
BFNE (n = 82)			
Time	1	11.70	< .001
Group	1	3.75	.06
Time x Group Interaction	1	10.14	< .01
OPQ (n = 84)			
Time	1	56.35	< .001
Group	1	3.66	.06
Time x Group Interaction	1	6.30	< .05
OCQ (n = 82)			
Time	1	33.14	< .001
Group	1	2.87	.09
Time x Group Interaction	1	9.26	< .01

Note: BFNE = Brief Fear of Negative Evaluation; OPQ = Outcome Probability Questionnaire; OCQ = Outcome Cost Questionnaire

Follow-up paired samples t-tests revealed that participants in the Treated group had significantly lower scores on the OPQ, OCQ, and BFNE at posttreatment compared to pretreatment. Participants in the Not Treated group did not have significantly lower scores on the BFNE post-wait; however, their scores on the OPQ and OCQ were significantly lower post-wait (See Table 3.4). However, treatment had a significantly greater effect on the OPQ and OCQ than no treatment, as evidenced by the significant interaction.

Table 3.4 Descriptive Statistics for the Outcome and Predictor Variables at Pretreatment and Posttreatment for Treated and Not Treated Participants (Step 1)

	Not Treated		Treated	
	Pre-wait	Post-wait	Pretreatment	Posttreatment
	<i>M (SD)</i>	<i>M (SD)</i>	<i>M (SD)</i>	<i>M (SD)</i>
BFNE	42.55 (9.77)	42.36 (10.16)	42.34 (8.98)	36.00 (7.97)
OPQ	52.42 (18.62)	41.88 (20.07)	51.81 (19.42)	28.74 (17.81)
OCQ	62.26 (17.49)	55.52 (18.07)	64.78 (15.69)	42.22 (21.81)

Note: Values in parentheses are standard deviations. BFNE = Brief Fear of Negative Evaluation; OPQ = Outcome Probability Questionnaire; OCQ = Outcome Cost Questionnaire

Step 2. Do reductions in judgmental biases predict reductions in social anxiety symptoms? To examine whether changes in judgmental biases predict reductions in social anxiety symptoms, additional analyses were conducted within the Treated group ($N = 76$) that employed the midtreatment data (see Table 3.5 for descriptive statistics).

Table 3.5 Descriptive Statistics for the Outcome and Predictor Variables at Pretreatment, Midtreatment, and Posttreatment (Step 2)

	Pretreatment	Midtreatment	Posttreatment
	<i>M (SD)</i>	<i>M (SD)</i>	<i>M (SD)</i>
BFNE	42.36 (9.07)	40.46 (9.06)	36.00 (7.97)
OPQ	51.73 (19.30)	37.93 (19.37)	28.74 (17.81)
OCQ	66.49 (12.72)	52.43 (19.76)	41.80 (21.97)

Note: Values in parentheses are standard deviations. BFNE = Brief Fear of Negative Evaluation; OPQ = Outcome Probability Questionnaire; OCQ = Outcome Cost Questionnaire

The midtreatment data were a necessary inclusion because a simple pre-post comparison would not allow for tests of whether changes in cognitive mechanisms temporally preceded changes in social anxiety symptoms. Structural equation modeling (SEM), specifically path analysis, was used to assess the fit between: (1) models hypothesizing specific presumed 'causal' relations among variables; and (2) the observed set of correlations between the variables in the models. SEM refers to a family of flexible sta-

tistical procedures based on covariances and means and applicable to both experimental and nonexperimental data (Kline, 2005). With SEM methodology, models are specified *a priori*, and models are tested for acceptable fit of the data to the hypothesized models and comparative fit across several hypothesized models using several fit indices. SEM framework allows error correction, missing data, and complex sample designs, and therefore provides a more powerful analysis than straightforward significance tests. Two main components of models are distinguished in SEM: the structural model, showing potential causal dependencies between endogenous and exogenous variables, and the measurement model, showing the relations between latent variables and their indicators. Path analysis can be viewed as a special case of SEM that involves a structural model, but no measurement model. It involves the estimation of presumed causal relations among observed variables and allows the simultaneous modeling of several related regression relationships (Muthèn & Muthèn, 1998-2010). When assessing direct effects of one variable on another over time, cross-lagged panel designs are among the most effective techniques (Kessler & Greenberg, 1981; Menard, 1991) and are useful in examining reciprocal relations among variables.

To test hypotheses, SEM software Mplus 6 (Muthèn & Muthèn, 1998-2010) with maximum-likelihood estimation to test the fit of a hypothesized model to the observed variance-covariance matrix, was used. Maximum likelihood estimation with robust standard errors allows for the use of all available data regardless of missing data at particular time points. According to Anderson and Gerbing (1988), the use of maximum likelihood estimation results in unbiased parameter estimates that are of practical importance when $N = 50$ or greater (as cited in Zacher, 2011).

Prior to conducting any SEM analyses, a model must first be specified. In the present study, a cross-lagged panel design path model was used to analyze the relation between social anxiety symptoms (BFNE) and cost and probability biases (OCQ, OPQ) at three time points: pretreatment, midtreatment, and posttreatment. The OPQ and OCQ were examined separately as predictors, and the BFNE

was the outcome measure. Figure 3.4 shows the hypothesized model with the OPQ as the predictor; an identical model was hypothesized with the OCQ as the predictor.

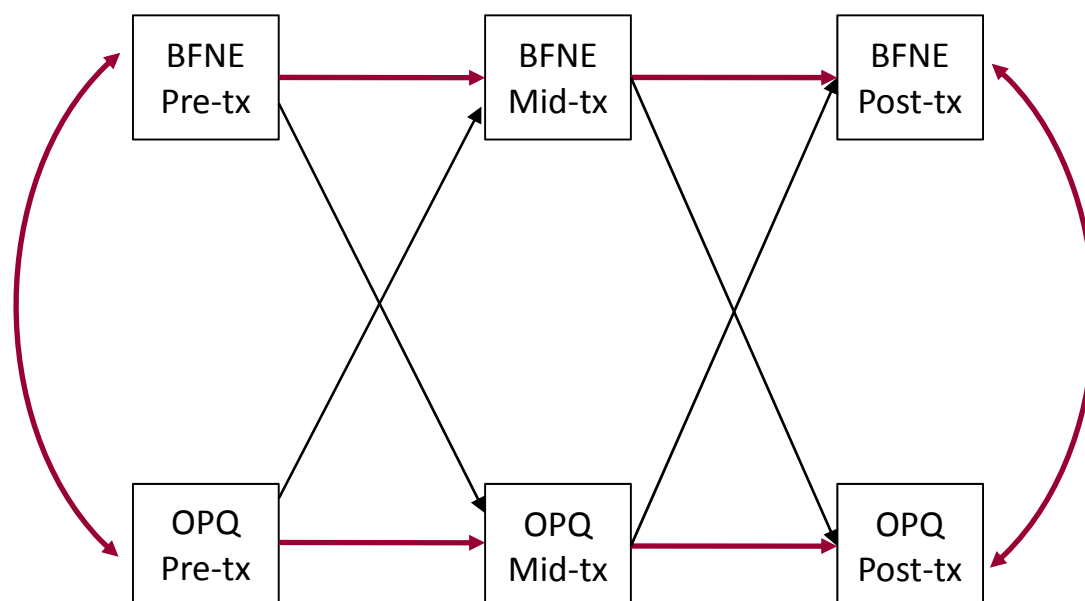

Figure 3.4 Hypothesized cross-lagged panel design path model

The cross-lagged panel design model includes the influence of judgmental biases at pretreatment and midtreatment on social anxiety symptoms at midtreatment and posttreatment respectively, and the influence of social anxiety symptoms at pretreatment and midtreatment on judgmental biases at midtreatment and posttreatment, respectively. These aspects of the model are referred to as the cross lags. The model also includes the influence of judgmental biases at pretreatment on judgmental biases at midtreatment, and the influence of judgmental biases at midtreatment on judgmental biases at posttreatment. The same is true for social anxiety symptoms. These aspects of the model, called autoregressive effects, can be thought of as indicators of the temporal stability of the measures. Estimations of these parameters in the model control for the stability of the variables across time. Thus any cross-lagged effects can be considered effects that add predictive power over and above that which can simply be obtained from within-construct stability over time. Finally, social anxiety symptoms and judgmental

tal biases were each allowed to intercorrelate within each time point, represented by curved, double-headed arrows. These aspects of the model are called synchronous correlations and account for covariances between judgmental biases and social anxiety symptoms that are not already explained by the influences of the variables from earlier time points. This design allowed for a test of the effect of the predictor variable at midtreatment on the outcome variable at posttreatment, while controlling for the predictor and outcome variable at all other time points. Thus this design allowed us to investigate the causal interplay between judgmental biases and social anxiety across treatment, allowing evaluation of whether early changes in judgmental biases (operationalized as scores at midtreatment, controlling for scores at pretreatment) drove later changes in social anxiety (operationalized as scores at posttreatment, controlling for scores at pre- and midtreatment), or whether early changes in social anxiety drove later changes in judgmental biases, or whether the relationship was reciprocal.

Zero-order correlations were first computed to determine whether the variables under investigation (BFNE, OPQ, OCQ) were related to each other. All expected auto- and intercorrelations were significant, with one exception: the OCQ at pretreatment was not significantly correlated with the OCQ at midtreatment (See Table 3.6).

Table 3.6 Correlation Matrix of All Hypothesis 2 Study Variables at Each Time Point

	1	2	3	4	5	6	7	8	9
1 Pre-BFNE	1	.72**	.52**	.47**	.47**	.34**	.36**	.41**	.24*
2 Mid-BFNE		1	.63**	.39**	.54**	.46**	.31**	.53**	.37**
3 Post-BFNE			1	.42**	.63**	.67**	.18	.46**	.52**
4 Pre-OPQ				1	.65**	.54**	.49**	.41**	.33**
5 Mid-OPQ					1	.81**	.11	.61**	.47**
6 Post-OPQ						1	.10	.60**	.65**
7 Pre-OCQ							1	.22	.24*
8 Mid-OCQ								1	.72**
9 Post-OCQ									1

Note: BFNE = Brief Fear of Negative Evaluation; OPQ = Outcome Probability Questionnaire; OCQ = Outcome Cost Questionnaire

The cross-lagged panel design path model was then evaluated for overall model fit. In line with the recommendations of Hoyle and Panter (1995), various measures of fit were used to evaluate the model. Absolute fit indices indicate the degree to which a pattern of fixed and free parameters specified in the model is consistent with the pattern of variances and covariances from the observed data. In the present study, the following absolute fit indices were used to evaluate the overall fit of each of the models: the Model Chi-Square (χ^2), the Root Mean Square Error of Approximation (RMSEA; Steiger, 1990), the Comparative Fit Index (CFI; Bentler, 1990), and the Standardized Root Mean Square Residual (SRMR). Information regarding these fit indices is detailed below.

The Model Chi-Square value is the traditional measure for evaluating overall model fit. It “assesses the magnitude of discrepancy between the sample and fitted covariance matrices” (Hu and Bentler, 1999, p. 2). A good model fit would provide a nonsignificant result at the $p < 0.05$ threshold (Barrett, 2007), thus the Chi-Square statistic is often referred to as a measure of ‘badness of fit’ (Kline, 2005).

The RMSEA indicates how well the model, with unknown but optimally chosen parameter estimates, would fit the population’s covariance matrix (Byrne, 1998). The RMSEA is regarded as “one of the most informative fit indices” due to its sensitivity to the number of estimated parameters in the model (Diamantopoulos & Sigawaw, 2000, p. 85). The RMSEA favors parsimony in that it will choose the model with the lesser number of parameters. Values of .01, .05, and .08 indicate excellent, good, and mediocre fit, respectively (MacCallum, Browne, & Sugawara, 1996). Confidence intervals for the RMSEA are also generally reported. In a well-fitting model, the lower limit is close to 0 while the upper limit should be less than 0.08.

The CFI assesses the model by comparing the χ^2 value of the model to the χ^2 of the null model. The null model is the worst case scenario, as it specifies that all measured variables are uncorrelated. The CFI takes into account sample size (Byrne, 1998) and performs well even when sample size is small (Tabachnick and Fidell, 2007). Values for this statistic range between 0.0 and 1.0 with values closer to

1.0 indicating good fit. A value of CFI ≥ 0.95 is presently recognized as indicative of good fit (Hu and Bentler, 1999).

The SRMR is the square root of the difference between the mean absolute value of the residuals of the sample covariance matrix and the hypothesized covariance model. Values for the SRMR range from zero to 1.0, with well-fitting models obtaining values less than .05 (Byrne, 1998; Diamantopoulos & Siguaw, 2000), however values as high as 0.08 are deemed acceptable (Hu & Bentler, 1999).

Cross-lagged model fitting- OPQ. The cross-lagged model was first evaluated for overall model fit using the OPQ as the predictor. The model had good indices of fit, with the exception of the upper limit of the RMSEA confidence interval: Model $\chi^2(4) = 4.221, p = 0.37$; RMSEA = 0.027 [0.000, 0.177]; CFI = 0.999; SRMR = 0.016. Next, the standardized parameter estimates of each proposed path were examined. Standardized parameter estimates are transformations of unstandardized estimates that remove scaling and can be used for comparisons of parameters throughout the model and across models. The standardized path estimates indicate the expected difference on the outcome variable in standard deviation units, given an increase in the predictor variable of one full standard deviation. Significant paths were determined through examination of the ratio of each parameter estimate to its standard error, which is distributed as a z statistic and is significant at the 0.05 level if its value exceeds 1.96 and at the 0.01 level if its value exceeds 2.56 (Hoyle, 1995). Figure 3.5 shows the path diagram results for the model. The standardized parameter estimates are shown, with their standard errors in parentheses. Significant parameter estimates are indicated with asterisks (*). As predicted, examination of individual paths revealed significant autoregressive effects and intercorrelations between variables at each time point. The full model also revealed a significant effect of pretreatment BFNE on midtreatment OPQ (Estimate = 0.201, $z = 2.111, p < .05$) and of midtreatment OPQ on posttreatment BFNE (Estimate = 0.393, $z = 4.096, p < .001$).

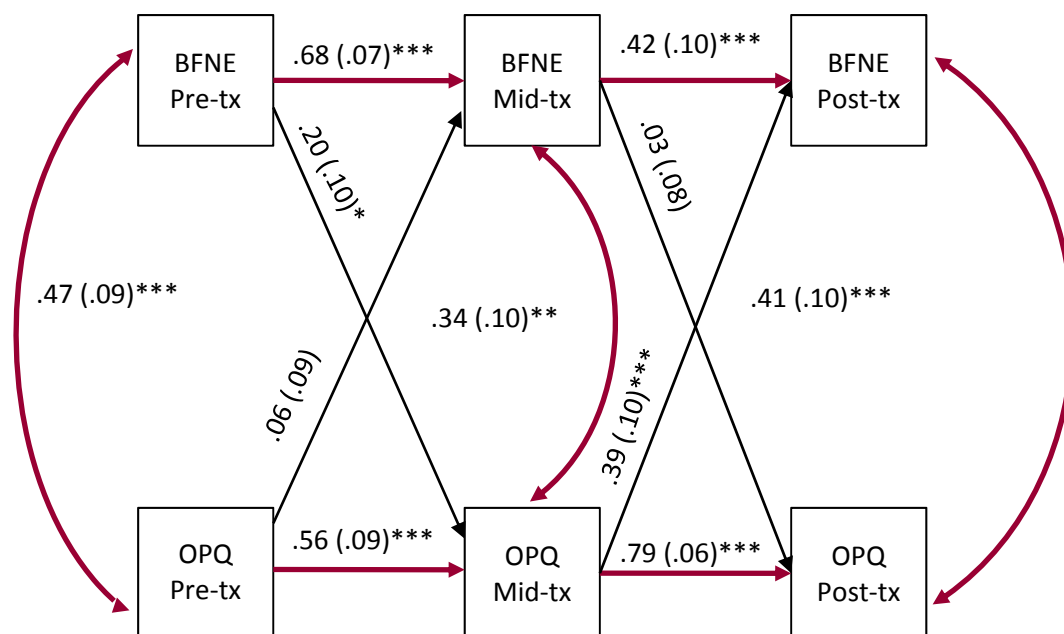

Figure 3.5 Cross-lagged panel design path diagram with the OPQ as the predictor

However, the cross lag from pretreatment OPQ to midtreatment BFNE was not significant (Estimate = 0.055, $z = 0.585$; $p = ns$); nor was the cross lag from midtreatment BFNE to posttreatment OPQ (Estimate = 0.030, $z = 0.367$, $p = ns$). Importantly, that the path from midtreatment OPQ to posttreatment BFNE is significant suggests that probability bias at midtreatment predicts social anxiety symptoms at post-treatment, while controlling for probability bias and social anxiety at all other time points. That the inverse is not true (i.e., that midtreatment BFNE does not predict posttreatment OPQ) provides further evidence that probability estimates drove treatment outcome, and not *vice versa*.

To obtain the most parsimonious model, a final model was calculated in which the non-significant paths were removed from the model. Chi-square difference tests and comparative fit indices—specifically the Bayes information Criterion (BIC; Schwarz, 1978; Raftery, 1993), and the sample-size adjusted BIC (saBIC; Sclove, 1987)—were used to determine if the fit of the model was reduced by removing these non-significant paths. A nonsignificant χ^2 difference test indicates that both models fit equally well statistically, so the parameters in question can be eliminated from the model (Schermelleh-

Engel, Moosbrugger, & Muller, 2003). The BIC is an alternative to the χ^2 goodness-of-fit test statistic that assigns a penalty to model complexity that is a function of the sample size. Thus the BIC is less influenced by large sample sizes and thus less prone to rejecting a more restrictive model when deviations between the baseline and restricted model are relatively small. However, the BIC penalizes for model complexity to a great degree. The BIC has been widely used for model identification in time series and linear regression analyses. Like the BIC, the saBIC penalizes for adding parameters based on the sample size, but does not place as high a penalty as the BIC. The saBIC has been used successfully with smaller samples (Lubke & Neal, 2006). The model with the lowest BIC and saBIC values has the best fit to the observed data.

Results of the chi-square difference tests showed that the fit of the model was not significantly reduced by removing these non-significant paths, and the comparative fit indices indicated that the model with the two nonsignificant paths removed was the best-fitting model (see Table 3.7).

Table 3.7 Chi-Square Difference Test Results and Comparative Fit Indices for Parsimonious OPQ Model

<i>Model</i>	χ^2_{Diff} Test Statistics				<i>BIC</i>	<i>saBIC</i>
	χ^2	<i>df</i>	$\Delta \chi^2 (df)$	<i>p</i>		
Full Model	4.221	4	-	-	3383.37	3310.87
Path from Pre-OPQ to Mid-BFNE removed	4.563	5	.342	.559	3379.38	3310.03
Path from Mid- BFNE to Post-OPQ removed	4.563	5	.342	.559	3379.17	3309.83
Both non-significant paths removed	4.696	6	.475	.789	3326.24	3308.99

Note: Note: BFNE = Brief Fear of Negative Evaluation; OPQ = Outcome Probability Questionnaire

Cross-lagged model fitting- OCQ. The cross-lagged model was then re-evaluated for overall model fit using the OCQ as the predictor. Analyses revealed a pattern of findings identical to those found when using the OPQ as the predictor. Again, the model had good indices of fit, with the exception of the upper limit of the RMSEA confidence interval: Model $\chi^2(4) = 4.971, p = 0.29$; RMSEA = 0.057 [0.000, 0.190]; CFI = 0.994; SRMR = 0.022. Figure 3.6 shows the path diagram results for the model.

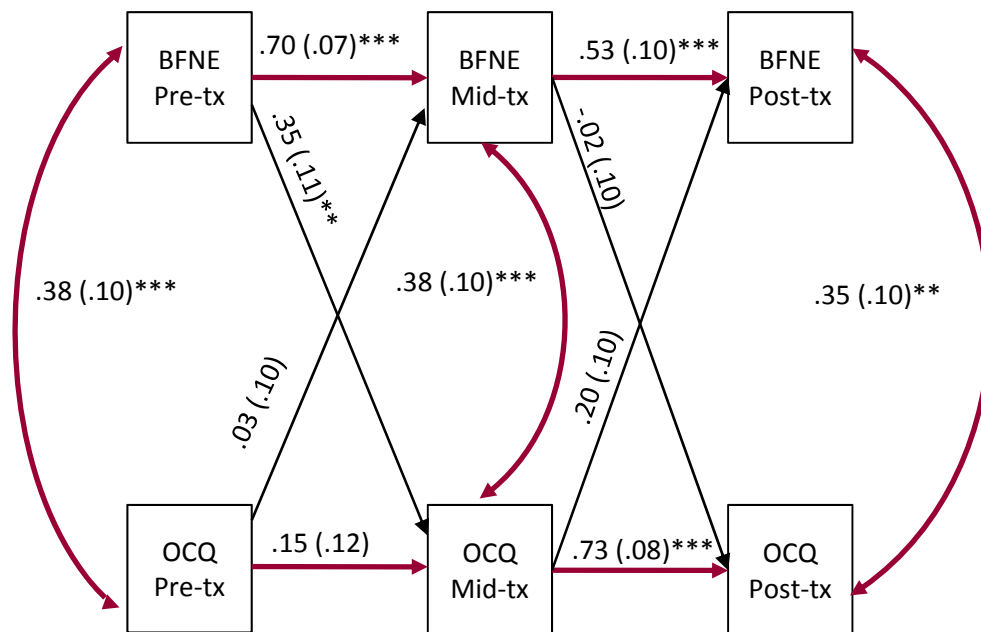

Figure 3.6 Cross-lagged panel design path diagram with the OCQ as the predictor

As with the OPQ, examination of individual paths revealed significant intercorrelations between variables at each time point; however, the OCQ at pretreatment was not predictive of the OCQ at midtreatment, suggesting this measure was not stable from pretreatment to midtreatment. Similar to the model with the OPQ, the model with the OCQ revealed a significant effect of pretreatment BFNE on midtreatment OCQ (Estimate = 0.346, $z = 3.158, p < .01$) and a significant effect of midtreatment OCQ on post-treatment BFNE (Estimate = 0.201, $z = 1.925, p = .05$). Also like the OPQ model, the cross lag from pretreatment OCQ to midtreatment BFNE was not significant (Estimate = 0.037, $z = 0.383; p = ns$); nor was

the cross lag from midtreatment BFNE to posttreatment OPQ (Estimate = -0.018, $z = -0.192$, $p = ns$). Importantly, that the path from midtreatment OCQ to posttreatment BFNE was significant suggests that cost bias at midtreatment predicts social anxiety symptoms at posttreatment, while controlling for cost bias and social anxiety at all other time points. That the inverse is not true (i.e., that midtreatment BFNE does not predict posttreatment OCQ) provides further evidence that cost estimates drove treatment outcome, and not *vice versa*.

To obtain the most parsimonious model for the OCQ, a final model was calculated in which the non-significant paths were removed from the model. Results of chi-square difference tests showed that the fit of the model was not significantly reduced by removing these non-significant paths, and comparative fit indices indicated the model without the three nonsignificant paths was the best-fitting model (see Table 3.8).

Table 3.8 Chi-Square Difference Test Results and Comparative Fit Indices for the Parsimonious OCQ Model

<i>Model</i>	χ^2_{Diff} Test Statistics				<i>BIC</i>	<i>saBIC</i>
	χ^2	<i>df</i>	$\Delta \chi^2$ (<i>df</i>)	<i>p</i>		
Full Model	4.971	4	-	-	3398.13	3325.63
Path from pre-OCQ to mid-BFNE removed	5.116	5	.145	.703	3393.94	3324.60
Path from mid-BFNE to post-OCQ removed	5.007	5	.036	.850	3393.93	3324.49
Path from pre-OCQ to mid-OCQ removed	6.381	5	1.410	.235	3395.21	3325.86
All 3 non-significant paths removed	6.419	7	1.448	.694	3386.58	3323.54

Note: Note: BFNE = Brief Fear of Negative Evaluation; OCQ = Outcome Cost Questionnaire

Step 3. Which is a stronger predictor of reductions in social anxiety symptoms: reductions in outcome cost or outcome probability estimates? To evaluate the relative influence of changes in cost versus probability estimates on treatment outcome, the standardized parameter estimate of the cross lag from the predictor variable at midtreatment to the outcome variable at posttreatment in the OPQ model was compared to the corresponding standardized parameter estimate in the OCQ model. By convention, standardized path coefficients with absolute values less than 0.10 may indicate a “small” effect, values around 0.30 indicate a “medium” effect, and values greater than 0.50, a “large” effect (Suhr, 2008). In the OPQ model, this path was statistically significant, and the effect size was medium-large (Estimate = .393). In the OCQ model, the path was also statistically significant ($p = .05$), and the effect size was medium-small (Estimate = .201). The OPQ estimate is approximately twice as large as—and 2 standard errors larger than—the OCQ estimate, suggesting that changes in the OPQ were a stronger predictor of treatment outcome in its model than changes in the OCQ were in its model.

4 CONCLUSIONS

The aims of the present investigation were to: 1.) examine the relation between judgmental biases and attentional biases in a clinical sample of adults diagnosed with social phobia; and 2.) examine whether changes in judgmental biases predict treatment outcome of CBT for social phobia.

With regard to the first aim, the hypothesis that greater attentional bias for threat in either direction (vigilance or avoidance) would predict higher cost and probability estimates was not supported, suggesting that there is not a simple dose-response relationship between attentional and judgmental biases. However, a significant relation was observed between attentional vigilance and outcome probability estimates, such that greater vigilance for threat predicted greater estimates of the likelihood that negative social events will occur. Given that this study was the first empirical investigation of the relation between judgmental and attentional biases, these findings are neither in contrast with nor con-

sistent with previous research. They can, however, be discussed in the context of extant theories of social phobia.

The finding that avoidance of threatening faces was not positively related to outcome cost or probability estimates is not in line with Clark and Wells' (1995) cognitive model of social phobia, which states that excessive self-focused attention (often operationalized as avoidance of external threat stimuli) prevents socially anxious individuals from processing social cues and receiving accurate information regarding social situations. However, other scholars (e.g. Pineles & Mineka, 2005) have aptly pointed out that self-focused attention and avoidance of external stimuli are not necessarily two sides of the same coin/construct—i.e., just because a person is avoiding external stimuli does not automatically mean s/he is attending to internal stimuli; thus attentional avoidance of external threat provides only indirect evidence that a person's attention is excessively self-focused.

The finding that there was a significant positive relation between attentional vigilance and probability bias is, however, consistent with Rapee and Heimberg's (1997) cognitive-behavioral model of social phobia, which states that probability estimates are "based on preceding stages of the model" (p. 749), one of which is the preferential allocation of attentional resources to external indicators of negative evaluation. This finding is also consistent with Heinrichs and Hofmann's (2001) assertion that biased attentional allocation is the pathway by which individuals with social phobia inaccurately interpret social threat. The cross-sectional design of the present study did not, however, allow for temporal or causal inferences; thus, it cannot be concluded (as hypothesized by Heinrichs & Hofmann) that attentional process served as a *precursor* to judgmental processes. Given that previous research has shown that attentional biases change with treatment for social phobia (Pishyar et al., 2007; Calamaras, Tone, & Anderson, 2012), future longitudinal research should examine whether the changes in attention bias associated with treatment predict or mediate changes in judgmental biases. Such a finding would provide support for notion that attentional processes serve as precursors to later interpretive processes.

That vigilance for—but not avoidance of—threat was related to probability estimates is of potential relevance to the small body of literature on attention bias subtypes, which argues that individuals who differ with regard to type of attention bias (avoidant or vigilant) may have different clinical profiles and/or responses to treatment (Price, Tone, & Anderson, 2011; Calamaras et al., 2012; Waters, Mogg, & Bradley, 2012). Alternatively, there may be methodological reasons why an avoidant attentional bias was not related to judgmental biases. First, the overall sample size ($N = 40$) was relatively small, and only 15 participants had an avoidant bias, which may have precluded adequate detection of potential trends in the data (i.e., a significant relation between attentional avoidance and, for example, cost estimates might have emerged in a larger sample). Second, although the dot probe task is a widely used measure of attention bias, scholars have raised issues with regard to its reliability (Schmukle, 2005; Staugaard, 2009) and ecological validity (Tone et al., 2013).

In the present study, there was a significant difference between Study 1 and Study 2 with regard to threat bias scores, such that participants from Study 1 evidenced a slight avoidant bias, whereas participants from Study 2 evidenced a vigilant bias. This finding was contrary to expectations and is not easily explained. The procedures of the pretreatment assessment (when the dot probe task was administered) were identical between Study 1 and Study 2 with two exceptions: Study 2's pretreatment assessments occurred approximately two years after Study 1's and included a mock fMRI. Given that no extremely salient national event (e.g., 9/11) occurred between Study 1 and Study 2 that might explain why the overall sample would become more vigilant, perhaps participants' knowledge of the upcoming mock fMRI primed them to be extra-vigilant for threat. However, by definition (i.e., study inclusion criteria), all participants in Study 2 were able to tolerate undergoing an fMRI. This unexplained finding, coupled with previous studies that have called into question the reliability and validity of the task, suggests that future research is needed to better understand the psychometric properties of the dot probe task. First, test-retest reliability in both clinical and control samples should be tested. Next, convergent validi-

ty could be examined by correlating performance on the dot probe task with other measures of attention bias (e.g., Stroop paradigm, Posner paradigm, eye-movement monitoring). Once the reliability and validity of the dot probe task have been satisfactorily established, the next step in the current line of research would be to replicate the findings of the present study in a larger sample, one more adequately powered to detect potential trends among avoidant participants.

With regard to the second aim, overall, the hypothesis that changes in cost and probability estimates would account for reductions in social anxiety symptoms was supported. Contrary to expectations, however, changes in probability bias were a stronger predictor of treatment outcome than changes in cost bias.

First, as predicted, it was found that CBT for social phobia had a significant effect on social anxiety symptoms as well as on outcome cost and probability estimates. Second, and also as hypothesized, it was found that both cost and probability estimates at midtreatment predicted social anxiety symptoms at posttreatment, while controlling for cost and probability estimates and social anxiety symptoms at all prior time points. Social anxiety symptoms at midtreatment did not predict cost and probability biases at posttreatment, suggesting that early changes in cost and probability biases were predictive of later changes in social anxiety symptoms, not *vice versa*. Third, when the relative contributions of changes in cost and probability biases to treatment outcome were compared, the effect size for probability estimates was medium-large (Estimate = .393), and the effect size for cost estimates was medium-small (Estimate = .201), suggesting that changes in probability estimates were a stronger predictor of treatment outcome than changes in cost estimates.

The findings of the present study are commensurate with previous research which has shown that cost and probability biases are influential in the treatment of social phobia. That treatment attenuated outcome cost and probability estimates is consistent with a sizable number of previous studies showing that these biases are responsive to CBT (Franklin et al., 2005; Luckock & Salkovskis, 1988; Poul-

ton & Andrews, 1996; Voncken & Bogels, 2006). Theoretically, the finding that early changes in cost and probability biases predicted later changes in social anxiety symptoms is consistent with Foa and Kozak's hypothesis that the efficacy of CBT in ameliorating pathological anxiety is mediated by reduction in the exaggerated probabilities and costs associated with feared consequences. In contrast with Foa and Kozak, however, the findings of this study do not support their assertion that exaggerated cost is more likely to underlie social anxiety than elevated probability, as changes in probability estimates were a stronger predictor of treatment outcome than were changes in cost. Thus this study provides support for the cognitive mediation hypothesis of social phobia and points to both outcome cost and outcome probability as potential mechanisms of treatment for social phobia.

The finding that probability bias is as important as—if not more important than—cost bias in the treatment of social phobia is particularly interesting given that, historically, fewer studies have examined probability bias as a mediator of treatment outcome. This disparity in the literature likely stems from Foa and Kozak's original (1986) argument that estimated social cost is the *primary* mediating variable of cognitive treatment change. More recently, other researchers have echoed this sentiment by arguing that cost bias is a particularly suitable target for intervention in social phobia because, whereas other anxiety disorders are characterized by overestimates of the probability of objectively catastrophic outcomes (e.g., heart attack in panic disorder, death of a loved one in generalized anxiety disorder), the feared outcomes in social phobia are not objectively dangerous (e.g., appearing foolish, being embarrassed; Hofmann & Scepkowski, 2006; Hofmann & Otto, 2008; Nelson, Lickel, Sy, Dixon, & Deacon, 2010). Our finding that probability bias was a stronger predictor of treatment outcome is consistent, however, with two of the four previous investigations that examined both cost and probability biases as mediators of treatment outcome (McManus et al., 2000; Smits et al., 2006). In both the present study and the investigation by Smits and colleagues (2006), all participants reported significant public speaking fears, which could call into question whether public speaking anxiety in particular is characterized by a

probability bias. However, McManus and colleagues' (2000) sample was not restricted to participants with substantial public speaking fears. Thus it seems unlikely that this finding is an artifact of the type of social fear targeted by treatment. Taken together, these studies and the present study suggest that it may be useful for researchers to increase the amount of attention dedicated to 1.) understanding probability bias as a treatment mechanism and 2.) developing probability-specific interventions, which heretofore have received less research attention than cost-specific interventions (e.g., Nelson et al., 2010).

There are a number of features of our methodological approach that are noteworthy. Prior to detailing these features, however, a brief discussion of the terms 'mediator' and 'mechanism' is warranted. In psychotherapy process research, these terms are often used interchangeably to refer to processes or events that lead to and cause therapeutic change. It is important to distinguish between conceptual mediation (a process or mechanism hypothesized to account for therapeutic change, e.g., Foa & Kozak's cognitive mediation hypothesis) and a formal statistical test of mediation. Distinguishing between statistical and conceptual mediation helps explain why some studies (e.g., Foa et al., 1996; McManus et al., 2000) have concluded that cost or probability biases "mediate" treatment outcome without completing formal tests of statistical mediation, and why other studies which did complete formal tests of mediation (e.g., Calamaras & Anderson, 2012) are limited in how informative they are.

A formal test of statistical mediation of the type outlined by Baron and Kenny (1986) would show that the effects of treatment versus no treatment on symptom improvement were eliminated or reduced after controlling for changes in the mediator. According to Kraemer et al.'s (2002) recommendations for identifying mediators of treatment effects in randomized clinical trials, to show that a variable is a mediator of treatment, the following steps must be demonstrated: 1.) treatment must be related to therapeutic change; 2.) treatment must be related to the proposed mediator; 3.) the proposed mediator must be related to therapeutic change; and 4.) the relation between treatment and therapeutic change must be reduced after statistically controlling for the proposed mediator. However, there are a number

of practical limitations to this approach, which have been detailed compellingly by Kazdin and Nock (2003) among others. The primary limitation of this approach is that the simple pre/post designs common to treatment outcome studies imply a timeline (i.e., that the mechanism led to the outcome), when really the data are cross-sectional. According to Kazdin and Nock, the study of mechanisms of change in therapy, or the reasons why therapy produces effects, requires repeated assessment during the course of treatment of both the proposed mechanism and symptom change to establish a time line (i.e., temporality). To date, studies of treatment mechanisms have consistently failed to establish that change in the proposed mechanism occurs before change in the outcome variable—a necessary precondition for deeming a variable a treatment mechanism. In the present study, examining cost and probability biases and their relation to social anxiety symptoms at pretreatment, midtreatment, and posttreatment, while controlling for autoregressive effects, allowed for a finer-grained analysis than simple pre/post designs. The cross-lagged panel allowed for effective delineation of the specific contribution of changes in judgmental biases to social anxiety symptom reduction and addressed the issue of temporal precedence by allowing for tests of whether early changes in probability and cost biases predicted later changes in social anxiety or *vice versa*.

Because we used midtreatment data to establish temporality, the analyses of the present study deviate from Kraemer's recommendations for testing mechanisms of action in randomized controlled trials. This deviation was due to the fact that midtreatment data were only available from participants who completed either of the two treatments in the study (i.e., not from the WL group); thus a formal test of statistical mediation could not be conducted. However, we were able to first establish that treatment had an effect on social anxiety symptoms as well as on cost and probability biases (see Step 1) prior to testing the relation between cost and probability biases and treatment outcome. Several previously published studies have utilized a similar multi-step approach when examining "mediation" of treatment outcome with pretreatment, posttreatment, and follow-up data, when follow-up data were

not available for their control group (e.g., Hofmann, 2004; Wilson & Rapee, 2005) or when data from a control group were not available (e.g., Smits et al., 2006; Nelson et al., 2010). Thus, though a statistical test of mediation was not conducted in the present study, the current project nonetheless addresses important limitations of the existing literature by providing a more methodologically rigorous test of the cognitive mediation hypothesis through its assessment of the temporality of the relations between judgmental biases and social anxiety.

In addition to addressing limitations of previous research regarding the temporality criterion, the current project contributes to the social phobia treatment mechanism literature in one other major way: it is the first to examine probability bias as a treatment mechanism in a typical (i.e., 8 weekly sessions with a clinical sample) treatment outcome study. Though related, cost and probability bias are conceptually distinct, making it important to examine each separately. In the present study, examining both cost and probability biases as potential mechanisms allowed us to compare the relative contributions of each to treatment outcome and examine whether one was more influential, a topic of considerable debate in the literature.

In spite of these significant methodological strengths, there are several limitations to the present study, some of which pertain to the measures used. First, contrary to expectations, treated participants' scores on the OCQ at pretreatment were not related to their scores on the OCQ at midtreatment. This unexpected finding, coupled with the fact that the non-treated WL participants' scores on both the OCQ and OPQ improved significantly over time (without treatment) raises concerns about whether participants' interpretation/understanding of these questionnaires was consistent across time. Given that the pretreatment OCQ was only included in the model to represent the amount of change from pretreatment to midtreatment, its lack of relation to itself at midtreatment should not have negative implications for the interpretation of the results. However, that the OPQ and OCQ changed over time without treatment does have potentially negative implications for cost and probability's status as treatment

mechanisms. Recall Kraemer et al.'s second step in establishing mediation in an RCT (treatment must be related to the proposed mediator). Though the significant Group x Time interaction shows that compared to WL, treatment was indeed associated with greater reductions in cost and probability estimates, this association would be strengthened if follow-up analyses had not revealed that these measures also changed significantly in the absence of treatment. The developers of the OPQ and OCQ (Uren et al., 2004) report high internal consistency for both measures (consistent with the present study), and results of an initial principal axis factor analysis support the construct validity of these questionnaires. However, no studies published to date have examined the test-retest reliability of either the OCQ or the OPQ. Thus future research is needed on the psychometric properties of these measures.

Second, treatment-related improvement on the outcome measure, though statistically significant, was modest. As all participants in the current study identified public speaking as their most feared social situation, exposure in our treatment protocol focused almost exclusively on public speaking exercises, which may have resulted in smaller change scores on the BFNE (a measure of broader evaluative concerns). Future studies should clarify whether the nature of the relationship between the modification of judgmental biases and social anxiety symptom reduction observed in the present study generalizes across participants with a range of social performance and interaction fears. Relatedly, the rate of comorbidity in the current sample (22%) is lower than what is typically found for individuals with social phobia. Despite lower levels of comorbidity, participants' self-report of social anxiety symptoms was elevated as compared with nonclinical samples (Duke, Krishnan, Faith, & Storch, 2006). Our sample was also atypical in that our participants were more highly educated than the population at large, which may have positively impacted their ability to understand the concept of judgmental biases and to recognize distorted cognitions as they occurred. Thus it is unknown the extent to which our findings would generalize to other more highly comorbid or less well-educated populations.

Third, the majority of studies which have examined judgmental biases in social phobia, including the present study, have relied exclusively on forced-choice self-report measures to assess probability and cost estimates as they pertain to hypothetical events. This represents a limitation of the literature, as designs are strengthened when multiple modes of assessment (e.g., behavioral, observer-report, and clinician-rated measures) are utilized (Weiner, Graham, & Naglieri, 2012). Future research on judgmental biases should employ more open-ended, qualitative, and behavioral methods of assessing these constructs.

A final limitation of the present study is that cost and probability were examined separately as predictors and not entered into the structural equation model simultaneously. Thus this design did not allow for tests of whether one type of judgmental bias was a *significantly* better predictor of treatment outcome than the other. As such, evidence regarding the relative importance of probability and cost biases in social phobia treatment remains mixed, and the question of which is comparatively more important unanswered. More research would be needed to establish whether one is a significantly greater predictor of treatment outcome than the other. Furthermore, this study did not test competing third variables as alternative treatment mechanisms (e.g., working alliance, treatment expectancy, anxiety sensitivity). Cost and probability's statuses as treatment mechanisms would be strengthened by modeling multiple potential mechanisms simultaneously, including plausible rival mechanisms, and parceling out the effects of each. This objective could also be achieved with research that systematically examines the effects of cost-specific versus probability-specific interventions to see if one condition demonstrates superiority.

In all likelihood, however, both cost and probability biases contribute significantly to treatment outcome. Evidence suggests that both function as treatment mechanisms, and elements of both are needed to create threat appraisals. That is, without the perception of negative consequences, an extremely likely event would not create fear, and without the possibility (likelihood) of an event occurring,

a catastrophic consequence would not create fear. Practicing clinicians should therefore continue to routinely assess and target both probability and cost biases in treatment. This recommendation is in line that of researchers (e.g., Wells, 1997; Antony & Swinson, 2008) who advocate for the use of behavioral experiments in which, following exposures that test the probability of negative social events (in which clients ideally learn that feared outcomes are not as probable as they had anticipated), clients should complete exercises in which they purposely commit social errors. For example, if an individual fears her hand will tremble during a presentation, she should first complete an exposure in which she attempts to give her presentation as competently as possible, followed by an additional exposure in which she purposely allows her hand to tremble. The dual nature of this approach allows individuals to learn that, not only are feared outcomes unlikely, even if such outcomes do occur, the consequences are not as catastrophic as imagined.

Though not a limitation *per se*, there is another aspect of the current project that should be noted. Both treatments delivered in this study specifically targeted cost and probability biases; however, they did so using different interventions and at different points in treatment. The VRE group received psychoeducation and cognitive restructuring that explicitly targeted these biases prior to the midtreatment assessment but did not begin exposure exercises until after the midtreatment assessment (in Session 5). The EGT group also received psychoeducation regarding these biases but no cognitive restructuring (e.g., ABC sheets); rather, the EGT group used cognitive preparations to specifically address these biases. Also, their exposure began prior to the midtreatment assessment. Thus this study was not designed to determine which components of treatment (psychoeducation, cognitive restructuring, cognitive preparation, exposure, or social mishap exercises) modified these biases. It is possible that, for the EGT group, these biases were modified solely through exposure, as exposure would have, in theory, led to new information about the probability and cost of harm associated with feared stimuli being incorporated into the fear structure.

This possibility is interesting in light of the current debate as to whether adding cognitive interventions improves outcomes relative to exposure-alone treatment (e.g., Longmore & Worrell, 2007). For example, in the depression literature, a substantial number of studies have demonstrated that strictly behavioral interventions (e.g., Behavioral Activation; Jacobson, Martell, & Dimidjian, 2001, Martell, Addis, & Jacobson, 2001) are as effective as interventions that include both cognitive and behavioral components. Dismantling studies such as these have been cited by Acceptance and Commitment theorists to challenge the commonly held notion that modifying distorting cognitions (versus accepting them, defusing from them, and changing one's relationship to them) should be a primary goal of treatment (e.g., Hayes et al., 1999; Hayes, 2004). Within the social phobia literature, however, the findings of dismantling studies present an unclear picture. Whereas early studies (Butler, Cullington, Munby, Amies, & Gelder, 1984; Mattick & Peters, 1988; Mattick, Peters, & Clarke, 1989) found that the effects of CBT exceeded those of exposure alone, Hope, Heimberg, & Bruch (1995) found that exposure alone was at least as effective as exposure plus cognitive intervention. Moreover, the results of several meta-analyses have shown that, though the effect sizes of CBT for social phobia are large, they do not exceed those of exposure alone (Fedoroff & Taylor, 2001; Feske & Chambless, 1995; Gould, Buckminster, Pollack, Otto & Yap, 1997; Powers, Sigmarsson, & Emmelkamp, 2008). Hofmann (2004) compared CBGT and EGT without explicit cognitive intervention and found that the two treatments did not differ significantly from one another at posttreatment; however, only participants who received CBGT showed continued improvement in the follow-up period, suggesting that cognitive interventions led to better maintenance of treatment gains.

Though the present study supports the centrality of cost and probability biases to treatment outcome, it does not necessarily contradict the above-referenced dismantling studies that have challenged the utility of explicit cognitive intervention. Were the findings of the present study to be replicated in the VRE treatment group only (which did not start exposure until after the midtreatment as-

essment), they would provide stronger evidence for the utility of explicitly targeting these biases with cognitive interventions. Thus an additional area for future research is to determine how cost- and probability-focused interventions exert their effects. Research comparing probability- and cost-focused cognitive interventions (e.g., cognitive restructuring, Socratic questioning, ABC worksheets) and probability- and cost-focused exposure exercises (e.g., traditional exposure, social mishap exercises) may be illuminative. In the absence of clarity on this issue, it would seem prudent for practicing clinicians to continue to place strong emphasis on assessing and modifying clients' judgmental biases through both explicit cognitive interventions and exposure.

In conclusion, theoretical models of social phobia posit that biased attention allocation may be related to judgmental biases. Though the empirical literature on the relation between attention bias and cost and probability biases is in its infancy, findings of the present study point to a potentially productive area of new research. However, preliminary steps are much needed before the relations between attentional and judgmental processes can be further delineated.

There is considerably more empirical support for the relation between judgmental biases and treatment outcome for social phobia. Several recent studies have yielded results consistent with the cognitive mediation hypothesis, which states that treatments for social phobia exert their effects through the modification of judgmental biases regarding the cost and probability of negative social events. The results of the present study extend and clarify the findings of previous investigations by adding to our knowledge about how changes in judgmental biases and social anxiety symptoms unfold over time. Our design and analytic approach have contributed to the scientific literature by yielding a more rigorous and conservative test of changes in judgmental biases as mechanisms by which CBT results in reduced social anxiety symptoms. Understanding the processes that account for therapeutic change is crucial for enhancing treatment efficacy and maximizing improvements for clients. Though further research is needed to ascertain the nature of their relation with other cognitive processes, such as atten-

tion bias, and to solidify their status as treatment mechanisms, the present study, coupled with the existing literature, suggests that these biases will likely be fruitful targets for further investigation.

REFERENCES

- Altman, D. G., Schulz, K. F., Moher, D., Egger, M., Davidoff, F., Elbourne, D., . . . Lang, T. (2001). The revised CONSORT statement for reporting randomized trials: Explanation and elaboration. *Annals of Internal Medicine*, *134*(8), 663-694. doi: 10.7326/0003-4819-134-8-200104170-00012
- Anderson, J. C., & Gerbing, D. W. (1988). Structural equation modeling in practice: A review and recommended two-step approach. *Psychological Bulletin*, *103*(3), 411-423. doi: 10.1037/0033-2909.103.3.411
- Anderson, P. L., Price, M., Edwards, S. M., Obasaju, M. A., Schmertz, S. K., Zimand, E., & Calamaras, M. R. (in press). Virtual reality exposure therapy for social phobia: A randomized controlled trial. *Journal of Consulting and Clinical Psychology*.
- Anderson, P. L., Zimand, E., Hodges, L. F., & Rothbaum, B. O. (2005). Cognitive behavioral therapy for public-speaking anxiety using virtual reality for exposure. *Depression and Anxiety*, *22*(3), 156-158. doi: 10.1002/da.20090
- Andrews, G., Freed, S., & Teesson, M. (1994). Proximity and anticipation of a negative outcome in phobias. *Behaviour Research and Therapy*, *32*(6), 643-645. doi: 10.1016/0005-7967(94)90020-5
- Antony, M. M., & Swinson, R. P. (2008). *The shyness and social anxiety workbook: Proven, step-by-step techniques for overcoming your fear (2nd ed.)*. Oakland, CA: New Harbinger Publications.
- APA (2000). *Diagnostic and statistical manual of mental disorders: DSM-IV-TR*. Washington, DC: American Psychiatric Publishing, Inc.
- Bar-Haim, Y., Lamy, D., Pergamin, L., Bakermans-Kranenburg, M. J., & van Ijzendoorn, M. H. (2007). Threat-related attentional bias in anxious and nonanxious individuals: A meta-analytic study. *Psychological Bulletin*, *133*(1), 1-24. doi: 10.1037/0033-2909.133.1.1
- Barlow, D. H. (2004). *Anxiety and its disorders: The nature and treatment of anxiety and panic*. New York: Guilford Publications, Incorporated.

- Baron, R. M., & Kenny, D. A. (1986). The moderator–mediator variable distinction in social psychological research: Conceptual, strategic, and statistical considerations. *Journal of Personality and Social Psychology, 51*(6), 1173-1182. doi: 10.1037/0022-3514.51.6.1173
- Barrett, P. (2007). Structural equation modelling: Adjudging model fit. *Personality and Individual Differences, 42*(5), 815-824. doi: 10.1016/j.paid.2006.09.018
- Basco, M. R., Bostic, J. Q., Davies, D., Rush, A. J., Witte, B., Hendrickse, W., & Barnett, V. (2000). Methods to improve diagnostic accuracy in a community mental health setting. *The American Journal of Psychiatry, 157*(10), 1599-1605. doi: 10.1176/appi.ajp.157.10.1599
- Beck, A. T. (1976). *Cognitive therapy and the emotional disorders*. New York: International Universities Press.
- Beck, A. T., Emery, G., & Greenberg, R. L. (2005). *Anxiety disorders and phobias: A cognitive perspective*. New York: Basic Books.
- Bentler, P. M. (1990). Comparative fit indexes in structural models. *Psychological Bulletin, 107*(2), 238-246. doi: 10.1037/0033-2909.107.2.238
- Bradley, B. P., Mogg, K., Millar, N., Bonham-Carter, C., Fergusson, E., Jenkins, J., & Parr, M. (1997). Attentional bias for emotional faces. *Cognition and Emotion, 11*(1), 25-42. doi: 10.1080/026999397380014
- Byrne, B. M. (1998). *Structural equation modeling with LISREL, PRELIS, and SIMPLIS: Basic concepts, applications, and programming*. Mahwah, NJ: Lawrence Erlbaum Associates Publishers.
- Calamaras, M. R., & Anderson, P. L. (2012). *Cost and probability biases as mediators of treatment outcome following cognitive behavioral therapy for social phobia*. Poster presented at the 46th annual meeting of the Association for Behavior and Cognitive Therapies, National Harbor, MD.
- Calamaras, M. R., Tone, E. B., & Anderson, P. L. (2012). A pilot study of attention bias subtypes: Examining their relation to cognitive bias and their change following cognitive behavioral therapy. *Jour-*

- nal of Clinical Psychology*, 68(7), 745-754. doi: 10.1002/jclp.21875
- Clark, D. M., & Wells, A. (1995). A cognitive model of social phobia. In R. G. Heimberg, M. R. Liebowitz, D. A. Hope, & F. R. Schneier (Eds.), *Social phobia: Diagnosis, assessment, and treatment* (pp. 69-93). New York: Guilford Press.
- Craske, M. G. (1999). *Anxiety disorders: psychological approaches to theory and treatment*. Boulder, CO: Westview Press.
- Des Jarlais, D. C., Lyles, C., & Crepaz, N. (2004). Improving the reporting quality of nonrandomized evaluations of behavioral and public health interventions: The TREND statement. *American Journal of Public Health*, 94(3), 361-366. doi: 10.2105/ajph.94.3.361
- Diamantopoulos, A. & Siguaw, J. A. (2000). *Introducing LISREL*. London: Sage Publications.
- Duke, D., Krishnan, M., Faith, M., & Storch, E. A. (2006). The psychometric properties of the Brief Fear of Negative Evaluation Scale. *Journal of Anxiety Disorders*, 20(6), 807-817. doi: 10.1016/j.janxdis.2005.11.002
- Fava, G. A., Grandi, S., Rafanelli, C., Ruini, C., Conti, S., & Belluardo, P. (2001). Long-term outcome of social phobia treated by exposure. *Psychological Medicine*, 31(5), 899-905. doi: 10.1017/s0033291701004020
- Fedoroff, I. C., & Taylor, S. (2001). Psychological and pharmacological treatments of social phobia: A meta-analysis. *Journal of Clinical Psychopharmacology*, 21(3), 311-324. doi: 10.1097/00004714-200106000-00011
- Fennig, S., Craig, T., Lavelle, J., Kovaszny, B., & Bromet, E. J. (1994). Best-estimate versus structured interview-based diagnosis in first-admission psychosis. *Comprehensive Psychiatry*, 35(5), 341-348. doi: 10.1016/0010-440x(94)90273-9
- Fergus, T. A., Valentiner, D. P., McGrath, P. B., Stephenson, K., Gier, S., & Jencius, S. (2009). The fear of positive evaluation scale: Psychometric properties in a clinical sample. *Journal of Anxiety Disor-*

- ders, 23(8), 1177-1183. doi: 10.1016/j.janxdis.2009.07.024
- Feske, U., & Chambless, D. L. (1995). Cognitive behavioral versus exposure only treatment for social phobia: A meta-analysis. *Behavior Therapy, 26*(4), 695-720. doi: 10.1016/s0005-7894(05)80040-1
- First, M. B., Spitzer, R. L., & Williams, J. B. W. (1997). *Structured clinical interview for DSM-IV Axis I Disorders: SCID-I : Clinician Version : Administration Booklet*. New York: Amer Psychiatric Pub Incorporated.
- Foa, E. B., Franklin, M. E., Perry, K. J., & Herbert, J. D. (1996). Cognitive biases in generalized social phobia. *Journal of Abnormal Psychology, 105*(3), 433-439. doi: 10.1037/0021-843x.105.3.433
- Foa, E. B., & Kozak, M. J. (1986). Emotional processing of fear: Exposure to corrective information. *Psychological Bulletin, 99*(1), 20-35. doi: 10.1037/0033-2909.99.1.20
- Franklin, M. E., Huppert, J., Langner, R., Leiberg, S., & Foa, E. B. (2005). Interpretation bias: A comparison of treated social phobics, untreated social phobics, and controls. *Cognitive Therapy and Research, 29*(3), 289-300. doi: 10.1007/s10608-005-2412-8
- Furmark, T., Tillfors, M., Stattin, H., Ekselius, L., & Fredrikson, M. (2000). Social phobia subtypes in the general population revealed by cluster analysis. *Psychological Medicine, 30*(6), 1335-1344. doi: 10.1017/s0033291799002615
- Garner, M., Mogg, K., & Bradley, B. P. (2006). Orienting and maintenance of gaze to facial expressions in social anxiety. *Journal of Abnormal Psychology, 115*(4), 760-770. doi: 10.1037/0021-843X.115.4.760
- Gilboa-Schechtman, E., Franklin, M. E., & Foa, E. B. (2000). Anticipated reactions to social events: Differences among individuals with generalized social phobia, obsessive compulsive disorder, and nonanxious controls. *Cognitive Therapy and Research, 24*(6), 731-746. doi: 10.1023/a:1005595513315

- Gillian, B., Anne, C., Mary, M., Peter, A., & Michael, G. (1984). Exposure and anxiety management in the treatment of social phobia. *Journal of Consulting and Clinical Psychology, 52*(4), 642-650. doi: 10.1037/0022-006x.52.4.642
- Gould, R. A., Buckminster, S., Pollack, M. H., Otto, M. W., & Yap, L. (1997). Cognitive-behavioral and pharmacological treatment for social phobia: A meta-analysis. *Clinical Psychology: Science and Practice, 4*(4), 291-306. doi: 10.1111/j.1468-2850.1997.tb00123.x
- Graham, J. R., Naglieri, J. A., & Weiner, I. B. (2013). *Handbook of psychology, Vol. 10: Assessment psychology (2nd ed.)*. Hoboken, NJ: John Wiley & Sons Inc.
- Hayes, S. C. (2004). Acceptance and commitment therapy and the new behavior therapies: Mindfulness, acceptance, and relationship. In S. C. Hayes, V. M. Follette & M. M. Linehan (Eds.), *Mindfulness and acceptance: Expanding the cognitive-behavioral tradition*. (pp. 1-29). New York, NY US: Guilford Press.
- Hayes, S. C., Strosahl, K. D., & Wilson, K. G. (1999). *Acceptance and commitment therapy: An experiential approach to behavior change*. New York, NY US: Guilford Press.
- Heimberg, R. C., Brozovich, F. A., & Rapee, R. M. (2010). A cognitive behavioral model of social anxiety disorder: Update and extension. In S. G. Hofmann & P. M. DiBartolo (Eds.), *Social anxiety: Clinical, developmental, and social perspectives (2nd ed.)*. (pp. 395-422). San Diego, CA US: Elsevier Academic Press.
- Heimberg, R. G. (2002). Cognitive-behavioral therapy for social anxiety disorder: Current status and future directions. *Biological Psychiatry, 51*(1), 101-108. doi: 10.1016/s0006-3223(01)01183-0
- Heimberg, R. G., Dodge, C. S., Hope, D. A., Kennedy, C. R., Zollo, L. J., & Becker, R. E. (1990). Cognitive behavioral group treatment for social phobia: Comparison with a credible placebo control. *Cognitive Therapy and Research, 14*(1), 1-23. doi: 10.1007/bf01173521
- Heimberg, R. G., Salzman, D. G., Holt, C. S., & Blendell, K. A. (1993). Cognitive-behavioral group treat-

- ment for social phobia: Effectiveness at five-year follow-up. *Cognitive Therapy and Research*, 17(4), 325-339.
- Heinrichs, N., & Hofman, S. G. (2001). Information processing in social phobia: A critical review. *Clinical Psychology Review*, 21(5), 751-770. doi: 10.1016/s0272-7358(00)00067-2
- Hofmann, S. G. (2000). Treatment of social phobia: Potential mediators and moderators. *Clinical Psychology: Science and Practice*, 7(1), 3-16. doi: 10.1093/clipsy/7.1.3
- Hofmann, S. G. (2002). *Exposure group therapy treatment manual*. Unpublished manuscript. Center for Anxiety and Related Disorders, Boston University, Boston, MA.
- Hofmann, S. G. (2004). Cognitive mediation of treatment change in social phobia. *Journal of Consulting and Clinical Psychology*, 72(3), 392-399. doi: 10.1037/0022-006x.72.3.392
- Hofmann, S. G., & Otto, M. W. (2008). *Cognitive behavioral therapy for social anxiety disorder*. New York: Routledge.
- Hofmann, S. G., & Scepkowski, L. A. (2006). Social self-reappraisal therapy for social phobia: Preliminary findings. *Journal of Cognitive Psychotherapy*, 20(1), 45-57. doi: 10.1891/jcop.20.1.45
- Hope, D. A., Heimberg, R. G., & Bruch, M. A. (1995). Dismantling cognitive-behavioral group therapy for social phobia. *Behaviour Research and Therapy*, 33(6), 637-650. doi: 10.1016/0005-7967(95)00013-n
- Hoyle, R. H. (1995). *Structural equation modeling: Concepts, issues, and applications*. Thousand Oaks, CA US: SAGE Publications.
- Hoyle, R. H., & Panter, A. T. (1995). *Writing about structural equation models*. Thousand Oaks, CA: Sage.
- Hu, L.-t., & Bentler, P. M. (1999). Cutoff criteria for fit indexes in covariance structure analysis: Conventional criteria versus new alternatives. *Structural Equation Modeling*, 6(1), 1-55. doi: 10.1080/10705519909540118
- Jacobson, N. S., Martell, C. R., & Dimidjian, S. (2001). Behavioral activation treatment for depression:

- Returning to contextual roots. *Clinical Psychology: Science and Practice*, 8(3), 255-270. doi: 10.1093/clipsy/8.3.255
- Kazdin, A. E., & Nock, M. K. (2003). Delineating mechanisms of change in child and adolescent therapy: methodological issues and research recommendations. *Journal of Child Psychology and Psychiatry*, 44(8), 1116-1129. doi: 10.1111/1469-7610.00195
- Kenny, D. A., Korchmaros, J. D., & Bolger, N. (2003). Lower level mediation in multilevel models. *Psychological Methods*, 8(2), 115-128. doi: 10.1037/1082-989x.8.2.115
- Kessler, R. C., Berglund, P., Demler, O., Jin, R., Merikangas, K. R., & Walters, E. E. (2005). Lifetime prevalence and age-of-onset distributions of DSM-IV disorders in the National Comorbidity Survey Replication. *Archives of General Psychiatry*, 62(6), 593-602. doi: 10.1001/archpsyc.62.6.593
- Kessler, R. C., Chiu, W. T., Demler, O., & Walters, E. E. (2005). Prevalence, severity, and comorbidity of 12-month DSM-IV disorders in the National Comorbidity Survey Replication. *Archives of General Psychiatry*, 62(6), 617-627. doi: 10.1001/archpsyc.62.6.617
- Kessler, R. C., & Greenberg, D. F. (1981). *Linear panel analysis: models of quantitative change*: Academic Press.
- Kline, R. B. (2005). *Principles and practice of structural equation modeling*. New York, NY US: Guilford Publications, Incorporated.
- Kraemer, H. C., Wilson, G. T., Fairburn, C. G., & Agras, W. S. (2002). Mediators and moderators of treatment effects in randomized clinical trials. *Archives of General Psychiatry*, 59(10), 877-883. doi: 10.1001/archpsyc.59.10.877
- Kranzler, H. R., Kadden, R. M., Babor, T. F., & Tennen, H. (1996). Validity of the SCID in substance abuse patients. *Addiction*, 91(6), 859-868. doi: 10.1111/j.1360-0443.1996.tb03580.x
- Longmore, R. J., & Worrell, M. (2007). Do we need to challenge thoughts in cognitive behavior therapy? *Clinical Psychology Review*, 27(2), 173-187. doi: 10.1016/j.cpr.2006.08.001

- Lubke, G., & Neale, M. C. (2006). Distinguishing between latent classes and continuous factors: Resolution by maximum likelihood? *Multivariate Behavioral Research*, *41*(4), 499-532. doi: 10.1207/s15327906mbr4104_4
- Lucock, M. P., & Salkovskis, P. M. (1988). Cognitive factors in social anxiety and its treatment. *Behaviour Research and Therapy*, *26*(4), 297-302. doi: 10.1016/0005-7967(88)90081-2
- MacCallum, R. C., Browne, M. W., & Sugawara, H. M. (1996). Power analysis and determination of sample size for covariance structure modeling. *Psychological Methods*, *1*(2), 130-149. doi: 10.1037/1082-989x.1.2.130
- Mansell, W., Clark, D. M., Ehlers, A., & Chen, Y.-P. (1999). Social anxiety and attention away from emotional faces. *Cognition and Emotion*, *13*(6), 673-690. doi: 10.1080/026999399379032
- Martell, C. R., Addis, M. E., & Jacobson, N. S. (2001). *Depression in context: Strategies for guided action*. New York, NY US: W W Norton & Co.
- Matthews, A., & Mackintosh, B. (1998). A cognitive model of selective processing in anxiety. *Cognitive Therapy and Research*, *22*(6), 539-560. doi: 10.1023/a:1018738019346
- Mattick, R. P., & Peters, L. (1988). Treatment of severe social phobia: Effects of guided exposure with and without cognitive restructuring. *Journal of Consulting and Clinical Psychology*, *56*(2), 251-260. doi: 10.1037/0022-006x.56.2.251
- Mattick, R. P., Peters, L., & Clarke, J. C. (1989). Exposure and cognitive restructuring for social phobia: A controlled study. *Behavior Therapy*, *20*(1), 3-23. doi: 10.1016/s0005-7894(89)80115-7
- McManus, F., Clark, D. M., & Hackmann, A. (2000). Specificity of cognitive biases in social phobia and their role in recovery. *Behavioural and Cognitive Psychotherapy*, *28*(3), 201-209. doi: 10.1017/s1352465800003015
- Menard, S. (1991). *Longitudinal research*. Newbury Park, CA US: Sage Publications.
- Mogg, K., & Bradley, B. P. (1999). Some methodological issues in assessing attentional biases for threat-

- ening faces in anxiety: A replication study using a modified version of the probe detection task. *Behaviour Research and Therapy*, 37(6), 595-604. doi: 10.1016/s0005-7967(98)00158-2
- Mogg, K., & Bradley, B. P. (2002). Selective orienting of attention to masked threat faces in social anxiety. *Behaviour Research and Therapy*, 40(12), 1403-1414. doi: 10.1016/s0005-7967(02)00017-7
- Mogg, K., Philippot, P., & Bradley, B. P. (2004). Selective attention to angry faces in clinical social phobia. *Journal of Abnormal Psychology*, 113(1), 160-165. doi: 10.1037/0021-843x.113.1.160
- Morgan, J., Price, M., Schmertz, S., Johnson, S., Masuda, A., Calamaras, M. R., & Anderson, P. L. (2013). *Cognitive processes as mediators of the relation between mindfulness and change in social anxiety symptoms following cognitive behavioral treatment*. Manuscript submitted for publication.
- Moscovitch, D. A., Antony, M. M., & Swinson, R. P. (2009). Exposure-based treatments for anxiety disorders: Theory and process. In M. M. Antony & M. B. Stein (Eds.), *Oxford handbook of anxiety and related disorders*. (pp. 461-475). New York, NY US: Oxford University Press.
- Muthèn, L. K., & Muthèn, B. O. (1998-2010). *Mplus User's Guide*. Sixth Edition. Los Angeles, CA: Muthèn & Muthèn.
- Nelson, E. A., Deacon, B. J., Lickel, J. J., & Sy, J. T. (2010). Targeting the probability versus cost of feared outcomes in public speaking anxiety. *Behaviour Research and Therapy*, 48(4), 282-289. doi: 10.1016/j.brat.2009.11.007
- Nelson, E. A., Lickel, J. J., Sy, J. T., Dixon, L. J., & Deacon, B. J. (2010). Probability and cost biases in social phobia: Nature, specificity, and relationship to treatment outcome. *Journal of Cognitive Psychotherapy: An International Quarterly*, 24(3), 213-228. doi: 10.1891/0889-8391.24.3.213
- Pineles, S. L., & Mineka, S. (2005). Attentional biases to internal and external sources of potential threat in social anxiety. *Journal of Abnormal Psychology*, 114(2), 314-318. doi: 10.1037/0021-843x.114.2.314
- Pishyar, R., Harris, L. M., & Menzies, R. G. (2008). Responsiveness of measures of attentional bias to clin-

- ical change in social phobia. *Cognition and Emotion*, 22(7), 1209-1227. doi: 10.1080/02699930701686008
- Poulton, R. G., & Andrews, G. (1996). Change in danger cognitions in agoraphobia and social phobia during treatment. *Behaviour Research and Therapy*, 34(5-6), 413-421. doi: 10.1016/0005-7967(96)00009-5
- Powers, M. B., Sigmarsson, S. R., & Emmelkamp, P. M. G. (2008). A meta-analytic review of psychological treatments for social anxiety disorder. *International Journal of Cognitive Therapy*, 1(2), 94-113. doi: 10.1521/ijct.2008.1.2.94
- Price, M., Tone, E. B., & Anderson, P. L. (2011). Vigilant and avoidant attention biases as predictors of response to cognitive behavioral therapy for social phobia. *Depression and Anxiety*, 28(4), 349-353. doi: 10.1002/da.20791
- Raftery, A. E. (1993). Bayesian model selection in structural equation models. In K. A. B. J. S. Long (Ed.), *Testing Structural Equation Models* Newbury Park, CA: Sage.
- Rapee, R. M., & Heimberg, R. G. (1997). A cognitive-behavioral model of anxiety in social phobia. *Behaviour Research and Therapy*, 35(8), 741-756. doi: 10.1016/s0005-7967(97)00022-3
- Rodebaugh, T. L., Holaway, R. M., & Heimberg, R. G. (2004). The treatment of social anxiety disorder. *Clinical Psychology Review*, 24(7), 883-908. doi: 10.1016/j.cpr.2004.07.007
- Ruscio, A. M., Brown, T. A., Chiu, W. T., Sareen, J., Stein, M. B., & Kessler, R. C. (2008). Social fears and social phobia in the USA: Results from the National Comorbidity Survey Replication. *Psychological Medicine*, 38(1), 15-28. doi: 10.1017/s0033291707001699
- Sadock, B. J., & Sadock, V. A. (2007). *Kaplan & Sadock's synopsis of psychiatry: Behavioral sciences/clinical psychiatry (10th ed.)*. Philadelphia, PA: Wolter Kluwer Health/Lippincott Williams & Wilkins.
- Schermelleh-Engel, K., Moosbrugger, H., & Müller, H. (2003). Evaluating the fit of structural equation

- models: Tests of significance and descriptive goodness-of-fit measures. *Methods of Psychological Research*, 8(2), 23-74. Accessed from: <http://www.dgps.de/fachgruppen/methoden/mpr-online/>
- Schmertz, S. K., Masuda, A., & Anderson, P. L. (2012). Cognitive processes mediate the relation between mindfulness and social anxiety within a clinical sample. *Journal of Clinical Psychology*, 68(3), 362-371. doi: 10.1002/jclp.20861
- Schneier, F. R., Johnson, J., Hornig, C. D., & Liebowitz, M. R. (1992). Social phobia: Comorbidity and morbidity in an epidemiologic sample. *Archives of General Psychiatry*, 49(4), 282-288. doi: 10.1001/archpsyc.1992.01820040034004
- Schultz, L. T., & Heimberg, R. G. (2008). Attentional focus in social anxiety disorder: Potential for interactive processes. *Clinical Psychology Review*, 28(7), 1206-1221. doi: 10.1016/j.cpr.2008.04.003
- Schwarz, G. (1978). Estimating the dimension of a model. *The Annals of Statistics*, 6(2), 461-464.
- Sclove, S. L. (1987). Application of model-selection criteria to some problems in multivariate analysis. *Psychometrika*, 52(3), 333-343. doi: 10.1007/bf02294360
- Smári, J., Bjarnadóttir, Á., & Bragadóttir, B. (1998). Social anxiety, social skills and expectancy/cost of negative social events. *Scandinavian Journal of Behaviour Therapy*, 27(4), 149-155. doi: 10.1080/02845719808408509
- Smits, J. A. J., Powers, M. B., Cho, Y., & Telch, M. J. (2004). Mechanism of change in cognitive-behavioral treatment of panic disorder: Evidence for the fear of fear mediational hypothesis. *Journal of Consulting and Clinical Psychology*, 72(4), 646-652. doi: 10.1037/0022-006x.72.4.646
- Smits, J. A. J., Rosenfield, D., McDonald, R., & Telch, M. J. (2006). Cognitive mechanisms of social anxiety reduction: An examination of specificity and temporality. *Journal of Consulting and Clinical Psychology*, 74(6), 1203-1212. doi: 10.1037/0022-006x.74.6.1203
- Stangier, U., Heidenreich, T., Peitz, M., Lauterbach, W., & Clark, D. M. (2003). Cognitive therapy for so-

- cial phobia: Individual versus group treatment. *Behaviour Research and Therapy*, 41(9), 991-1007. doi: 10.1016/s0005-7967(02)00176-6
- Staugaard, S. R. (2009). Reliability of two versions of the dot-probe task using photographic faces. *Psychology Science*, 51(3), 339-350.
- Steiger, J. H. (1990). Structural model evaluation and modification: An interval estimation approach. *Multivariate Behavioral Research*, 25(2), 173-180. doi: 10.1207/s15327906mbr2502_4
- Stein, M. B., & Kean, Y. M. (2000). Disability and quality of life in social phobia: Epidemiologic findings. *The American Journal of Psychiatry*, 157(10), 1606-1613. doi: 10.1176/appi.ajp.157.10.1606
- Stein, M. B., Torgrud, L. J., & Walker, J. R. (2000). Social phobia symptoms, subtypes, and severity: Findings from a community survey. *Archives of General Psychiatry*, 57(11), 1046-1052. doi: 10.1001/archpsyc.57.11.1046
- Stopa, L., & Clark, D. M. (2000). Social phobia and interpretation of social events. *Behaviour Research and Therapy*, 38(3), 273-283. doi: 10.1016/s0005-7967(99)00043-1
- Suhr, D. (2008). *Step your way through path analysis*. Paper presented at the 16th Annual Western Users of SAS® Software Regional Conference, November 5-7, 2008, Universal City, California.
- Tabachnick, B. G., & Fidell, L. S. (2007). *Experimental designs using ANOVA*. Belmont, CA: Thomson/Brooks/Cole.
- Tone, E. B., Fani, N., Jovanovic, T., Kamkwalala, A., Karapanou, I., Ressler, K. J., & Bradley, B. (2013). *Post-traumatic stress disorder moderates attention bias for facial threat cues based on cue race and emotional valence*. Manuscript submitted for publication.
- Uren, T. H., Szabó, M., & Lovibond, P. F. (2004). Probability and cost estimates for social and physical outcomes in social phobia and panic disorder. *Journal of Anxiety Disorders*, 18(4), 481-498. doi: 10.1016/s0887-6185(03)00028-8
- Voncken, M. J., & Bögels, S. M. (2006). Changing interpretation and judgmental bias in social phobia: A

- pilot study of a short, highly structured cognitive treatment. *Journal of Cognitive Psychotherapy*, 20(1), 59-73. doi: 10.1891/jcop.20.1.59
- Wallace, S. T., & Alden, L. E. (1995). Social anxiety and standard setting following social success or failure. *Cognitive Therapy and Research*, 19(6), 613-631.
- Waters, A. M., Mogg, K., & Bradley, B. P. (2012). Direction of threat attention bias predicts treatment outcome in anxious children receiving cognitive-behavioural therapy. *Behaviour Research and Therapy*, 50(6), 428-434. doi: 10.1016/j.brat.2012.03.006
- Watson, D., & Friend, R. (1969). Measurement of social-evaluative anxiety. *Journal of Consulting and Clinical Psychology*, 33(4), 448.
- Weeks, J. W., Heimberg, R. G., Fresco, D. M., Hart, T. A., Turk, C. L., Schneier, F. R., & Liebowitz, M. R. (2005). Empirical validation and psychometric evaluation of the Brief Fear of Negative Evaluation Scale in patients with social anxiety disorder. *Psychological Assessment*, 17(2), 179-190.
- Weeks, J. W., Heimberg, R. G., Rodebaugh, T. L., & Norton, P. J. (2008). Exploring the relationship between fear of positive evaluation and social anxiety. *Journal of Anxiety Disorders*, 22(3), 386-400. doi: 10.1016/j.janxdis.2007.04.009
- Weiner, I. B., Graham, J. R., & Naglieri, J. A. (2012). *Handbook of Psychology, Assessment Psychology*: Wiley.
- Wells, A. (1997). *Cognitive therapy of anxiety disorders: A practical guide*. West Sussex, England: John Wiley & Sons, Limited.
- Wells, A., White, J., & Carter, K. (1997). Attention training: Effects on anxiety and beliefs in panic and social phobia. *Clinical Psychology & Psychotherapy*, 4(4), 226-232.
- Wilson, J. K., & Rapee, R. M. (2005). Interpretative biases in social phobia: Content specificity and the effects of depression. *Cognitive Therapy and Research*, 29(3), 315-331.

Zacher, H., & de Lange, A. H. (2011). Relations between chronic regulatory focus and future time perspective: Results of a cross-lagged structural equation model. *Personality and Individual Differences*, 50(8), 1255-1260.

APPENDICES

Appendix A

Demographic Information

Gender:

- Male
 Female

Age: _____

Date of Birth: _____

Racial/Ethnic Origin:

- African American
 Caucasian
 Hispanic
 Asian American
 Pacific Islander
 American Indian
 Other _____

Highest level of Education Completed:

- Some high school
 Completed high school
 Some college (1-2 years)
 Some college (3+ years)
 Completed college degree
 Some graduate school
 Completed graduate degree

Current Marital Status:

- Single
 Married
 Separated
 Divorced
 Living with someone
 Widowed

Current Total Annual Household Income:

- Less than \$ 5,000
 \$ 5,000 - \$ 10,000
 \$ 10,000 - \$ 20,000
 \$ 20,000 - \$ 30,000
 \$ 30,000 - \$ 50,000
 More than \$ 50,000

Appendix B

BFNE

Read each of the following statements and then use the scale below to indicate the degree to which each statement applies to you, use the blank to enter the number that corresponds to your answer for each question.

1	2	3	4	5
Not at All	Slightly	Moderately	Very	Extremely

1. I worry about what other people will think of me even when I know that it doesn't make any difference. _____
2. I am unconcerned even if I know people are forming an unfavorable opinion of me. _____
3. I am frequently afraid of other people noticing my short comings. _____
4. I rarely worry about what kind of impression I am making on someone. _____
5. I am afraid that others will not approve of me. _____
6. I am afraid that people will find fault in me. _____
7. Other people's opinions of me do not bother me. _____
8. When I am talking to someone, I worry about what they may be thinking about me. _____
9. I am usually worried about what kind of impression I make. _____
10. If I know someone is judging me, it has little effect on me. _____
11. Sometime I think I am too concerned with what other people think of me. _____
12. I often worry that I will say or do wrong things. _____

Appendix D

OCQ

Please rate how **bad** or **distressing** the following outcomes would be for you if they were to occur in a public speaking situation? Use the "0-8" scale below to indicate your answer, with "0" indicating that the outcome listed would be *not at all distressing* and "8" indicating the outcome listed would be *extremely distressing*.

0	1	2	3	4	5	6	7	8
Not at all distressing							Extremely distressing	

1. You were embarrassed by something you did
2. You sounded dumb to others
3. You felt flustered in front of others
4. People thought that you were boring
5. At a party, others noticed that you were nervous
6. During a job interview or evaluation, you froze
7. While you were talking with several people, one of them left
8. You were ignored by someone you knew
9. You did something foolish in public
10. You failed to accomplish an important goal
11. You failed to cope in your day-to-day living
12. You were unexpectedly called in to see your supervisor at work